

Alarm Recording Adaptor

Operation Manual _____ **EN**

Mode d'emploi _____ **FR**

Owner's Record

The model and serial numbers are located on the bottom. Record the serial number in the space provided below. Refer to these numbers whenever you call upon your Sony dealer regarding this product.

Model No. PGV-250 Serial No. _____

PGV-250/250P

WARNING

To prevent fire or shock hazard, do not expose the unit to rain or moisture.



This symbol is intended to alert the user to the presence of important operating and maintenance (servicing) instructions in the literature accompanying the appliance.

CAUTION (PGV-250 only)

You are cautioned that any changes or modifications not expressly approved in this manual could void your authority to operate this equipment.

Note

This equipment has been tested and found to comply with the limits for a Class B digital device, pursuant to Part 15 of the FCC Rules. These limits are designed to provide reasonable protection against harmful interference in a residential installation. This equipment generates, uses, and can radiate radio frequency energy and, if not installed and used in accordance with the instructions, may cause harmful interference to radio communications. However, there is no guarantee that interference will not occur in a particular installation. If this equipment does cause harmful interference to radio or television reception, which can be determined by turning the equipment off and on, the user is encouraged to try to correct the interference by one or more of the following measures:

- Reorient or relocate the receiving antenna.
- Increase the separation between the equipment and receiver.
- Connect the equipment into an outlet on a circuit different from that to which the receiver is connected.
- Consult the dealer or an experienced radio/TV technician for help.

Contents

Contents	1
Operation	3
Care	3
Maintenance	3
Overview of the PGM-250/250P	4
Features	4
Menu Screen	5
Checking the Shipping Contents	5
Location of Parts and Controls	7
Installing a Lithium Battery	8
Connections	10
Attaching this Adaptor to the Video Walkman ...	10
Connecting a Monitor to the Video Walkman	11
Connecting Video Source Equipment	12
Connecting Audio Source Equipment	14
Connecting Alarm Equipment	15
Power Supply	16
Turning the Power On	16
Setting the Clock and the Clock Display Position	17
Optional Setting Up	22
Setting the OPTIONAL SETUP Menu	22
Setting the Program Recording Conditions	25
What is the Program Recording?	25
Selecting the REC MODE SETUP Menu	26
Setting of Each Item in the REC MODE SETUP Menu	27
Setting the ALARM Recording Mode	28
Setting the CONTI REC (Continuous Recording) Mode	33
Setting the TIMER Recording Mode and Timer Programs	35
Entering the Program Recording Mode	40
Changing the Settings	41
Checking the Settings	42
Checking the Alarm List	43
Resuming Playback	45
Troubleshooting	46

Contents

Specifications	47
Relation Between Program Recording Condition and Recording Operation	49
Duration Setting	49
Recording Without Using the Timer	49
Timer Recording	51
Setting for Your Purpose	53

Precautions

Operation

- Should any solid object or liquid fall into the cabinet, unplug the unit and have it checked by qualified personnel before operating it any further.
- Avoid rough handling or mechanical shock to the unit.
- Do not wrap up the unit and operate it because heat may build up internally.
- Avoid using and storing the unit in the following locations:
 - susceptible to vibration
 - exposed to strong magnetic fields
 - near TV or radio transmitters where strong radio waves are generated
 - on the sand
 - near heat sources such as radiators or air ducts
 - subject to direct sunlight or excessive dust
- Do not leave the unit in a car or in a trunk.

Care

- Clean the unit body with a dry, soft cloth, or a soft cloth lightly moistened with a mild detergent solution. Do not use any type of solvent which may damage the finish.

Maintenance

- The built-in clock of the unit may not work correctly due to temperature change, etc.
Check the clock occasionally and set the time again if necessary.
- About one year of normal operation can be expected with the supplied lithium battery. We recommend replacing the battery before it is completely run down.
- Take care of the Video Walkman while referring to the operation manual supplied with it.

Overview of the PGV-250/250P

The PGV-250/250P is an alarm recording adaptor designed to be used with the Video Walkman.

By connecting the Video Walkman and a camera (or another video source) to this adaptor, you can perform program recording, date/time superimposition, and so on.

Features

- Time/date superimposition
- Program recording

By program setting, you can perform three types of recording.

ALARM mode:

Starts recording automatically when an alarm signal is input to this adaptor.

CONTI REC (Continuous Recording) mode:

keeps recording even if you press (stop) or PAUSE **||** on the Video Walkman by mistake.

TIMER mode:

starts and stops recording at the time you set and the recording is performed in ALM (alarm) or CREC (Continuous Recording) mode.

- Alarm signal output to show the program recording status (You can set the alarm signal to be output while a program recording is made, or when the tape reaches its end.)
- Back up function to resume the former status after the recovery of a power failure
- Alarm list to show you the time and cause of each alarm recording with its alarm number
- Automatic repeat function to rewind the tape when the tape reaches its end
- CHECK screen to confirm the settings
- Built-in microphone amplifier

Menu Screen

This adaptor is equipped with a menu screen function. You can perform most of the operations on the menu screen displayed on a monitor connected to the Video Walkman.

Menu item	Setting purpose	Page
LOG LIST	To see the log list.	43
REC MODE SETUP	To select a program recording mode (ALARM, CONTI REC, or TIMER)	25
TIMER SETUP	To preset the TIMER settings and set the conditions of the alarm/timer recordings	35
CLOCK SETUP	To set the date, the time, and the clock display position	17
OPTIONAL SETUP	To select the optional output; TAPE END(tape-end-out) or REC (recording-indication-out), type of audio source; LINE (line input) or MIC (microphone input) .	22

Checking the Shipping Contents

Check that the followings are present in the package.

PGV-250/250P Alarm Recording Adaptor (1)

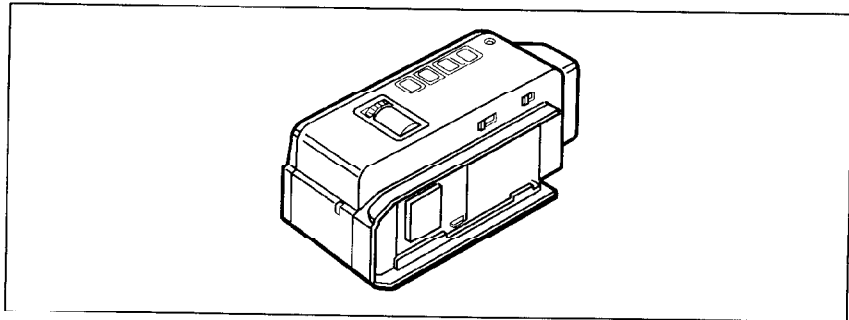

PAD-250 Battery Adaptor (1)

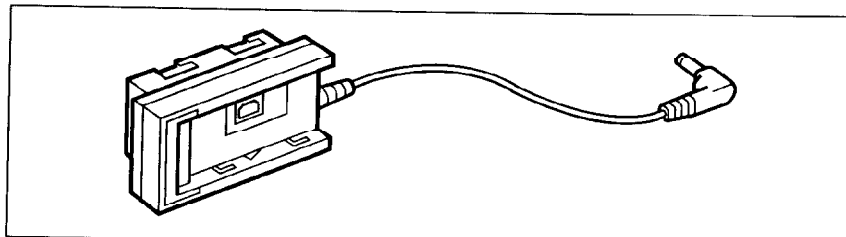

Overview of the PGV-250/250P

DC power cord (1)

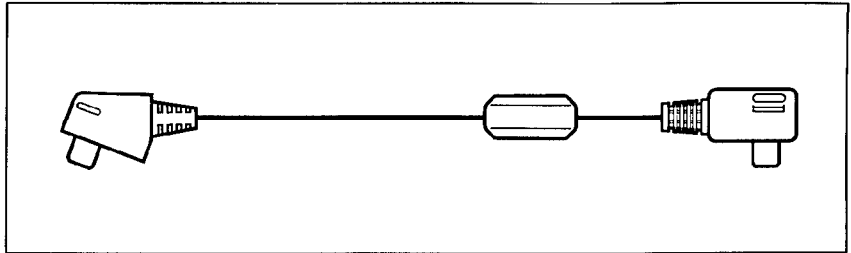

Branch cable with mini-stereo plugs (1)

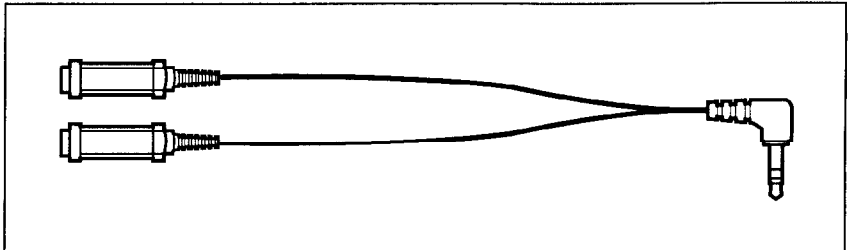

S-video cable (1)

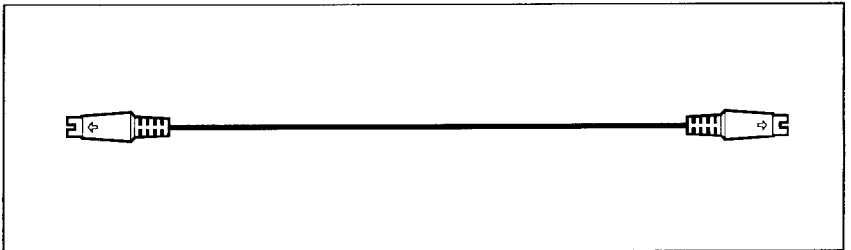

AV cable (1)

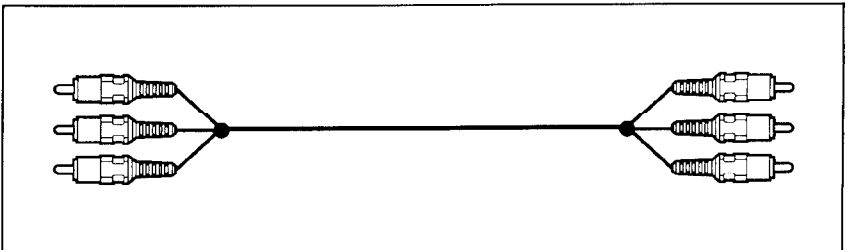

Lithium battery (CR2032) (1)

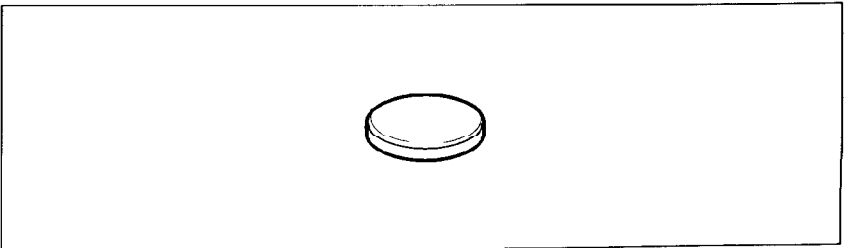

Location of Parts and Controls

PGV-250/250P Alarm Recording Adaptor

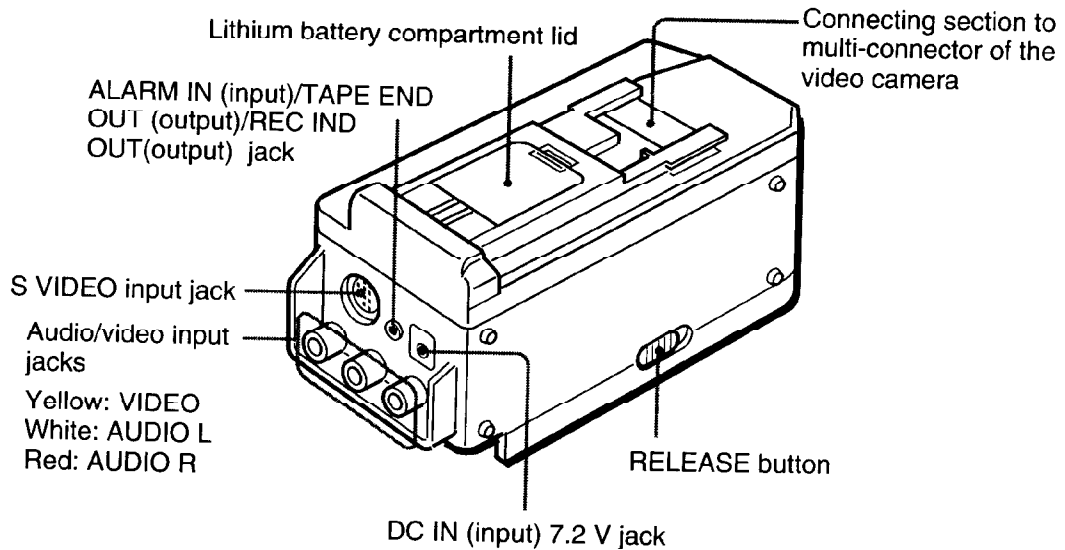
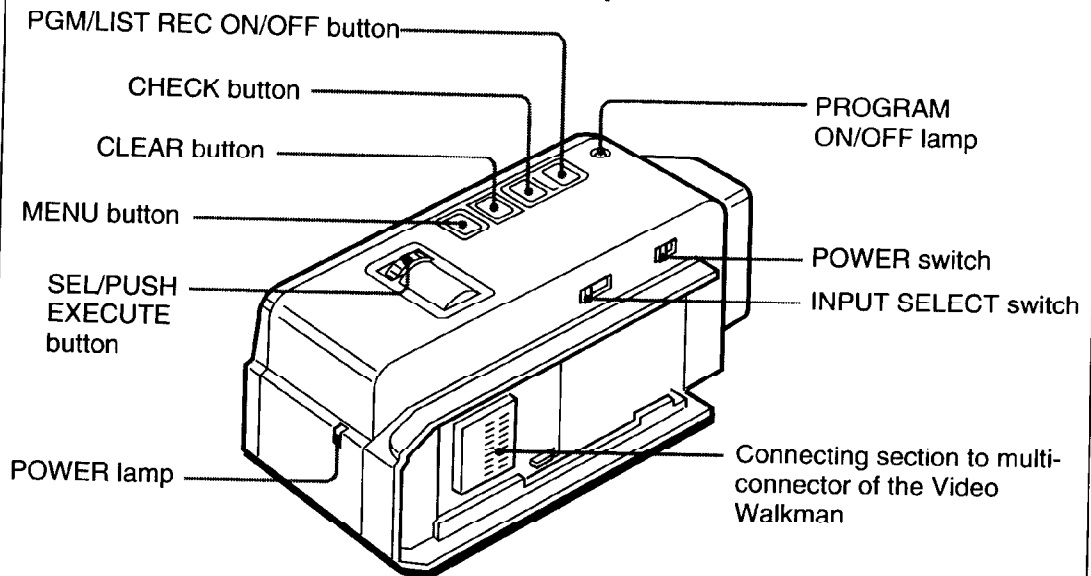

PAD-250 Battery Adaptor

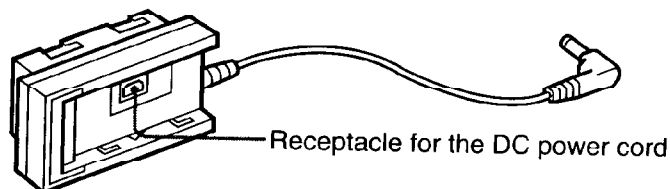

Installing a Lithium Battery

When this adaptor is connected to the Video Walkman and to an AC power source, the power for this adaptor is supplied via the PAD-250 Battery Adaptor. The only other power needed by this adaptor is a lithium battery to power the clock and keep the settings and the alarm list in memory, even when the host power to the Video Walkman is interrupted or this adaptor is disconnected from the Video Walkman.

- 1 Open the lid of the lithium battery compartment.

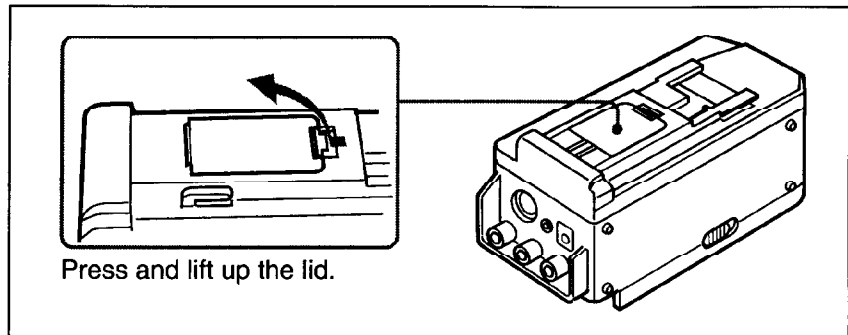

- 2 Install the supplied CR2032 lithium battery with the + side facing out.

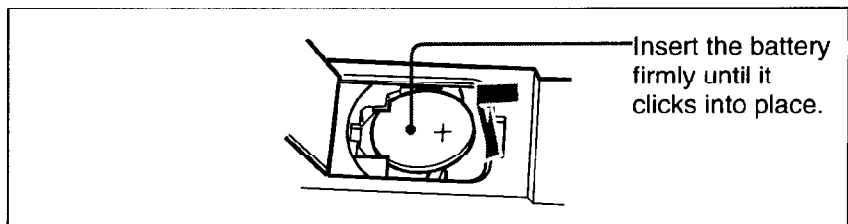

- 3 Close the lid.

To remove the lithium battery

Push the battery forward and remove it as illustrated.

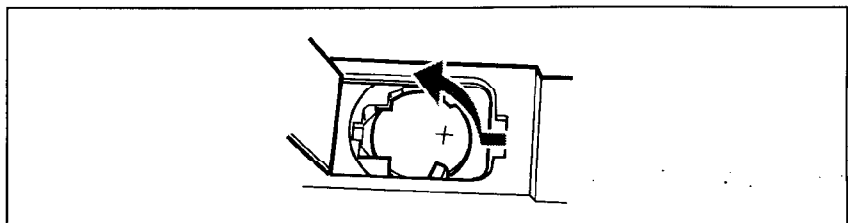

Lithium battery life

Approximately one year is expected in normal operation. If the lithium battery becomes weak, "Backup Battery Low" appears on the monitor when the adaptor is in normal screen mode.

In this case, replace the battery with a Sony CR2032 lithium battery. Use of another battery may present a risk of fire or explosion. After replacing the battery, set the clock again.

Caution

- Keep the lithium battery out of the reach of children. Should the battery be swallowed, consult a doctor immediately.
- Before use, wipe the battery with a dry cloth to assure a good contact.
- Be sure to observe the correct polarity when installing the battery.
- Do not hold the battery with metallic tweezers, as that may cause a short-circuit.
- Do not break up the battery or throw it into a fire because it may explode. Carefully dispose of the used batteries.

Warning

Battery may explode if mistreated. Do not recharge, disassemble or dispose of in fires.

Connections

Attaching this Adaptor to the Video Walkman

- 1** Remove the left side cover of the Video Walkman while sliding the RELEASE lever in the direction of the arrow (→).

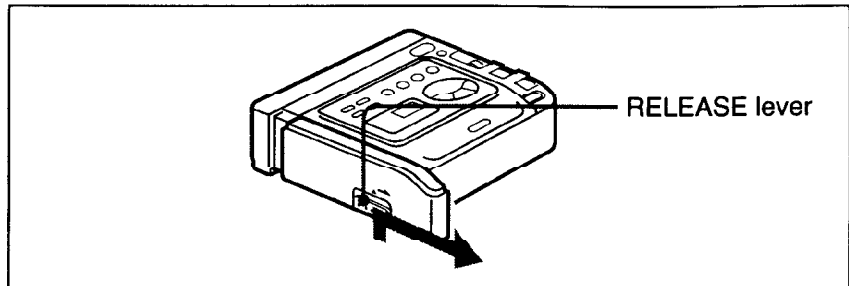

- 2** Align the edge of the flap of this adaptor to the mark on the Video Walkman as illustrated, then slide the adaptor backward until it clicks.

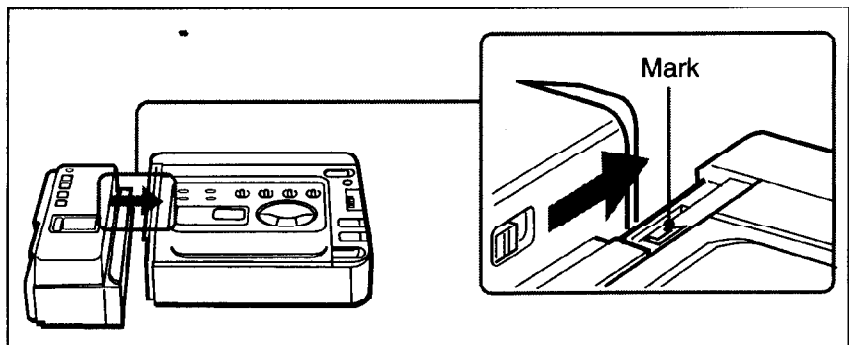

- 3** Connect the PAD-250 Battery Adaptor (supplied with this adaptor) to the Video Walkman as illustrated, and connect the cable of the PAD-250 to the DC IN 7.2 V jack of this adaptor.

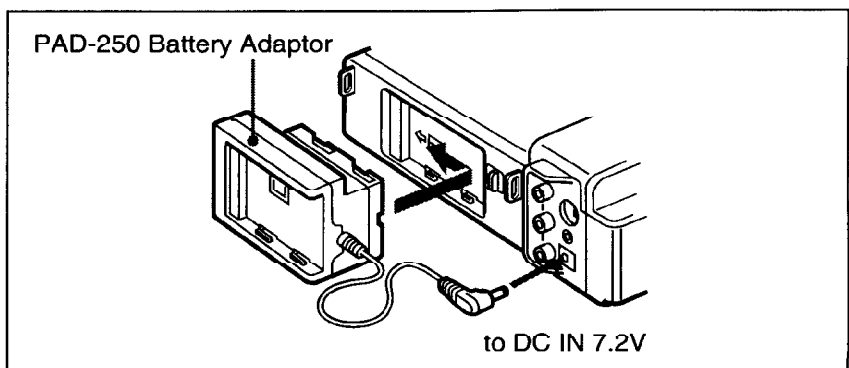

Note

If nothing will be connected to the left side of this adaptor, it is recommended to attach the left side cover of the Video Walkman to this adaptor to protect the exposed connecting sections.

To remove this adaptor from the Video Walkman

Pull this adaptor forward while sliding the RELEASE lever on the adaptor in the direction of the arrow (➡).

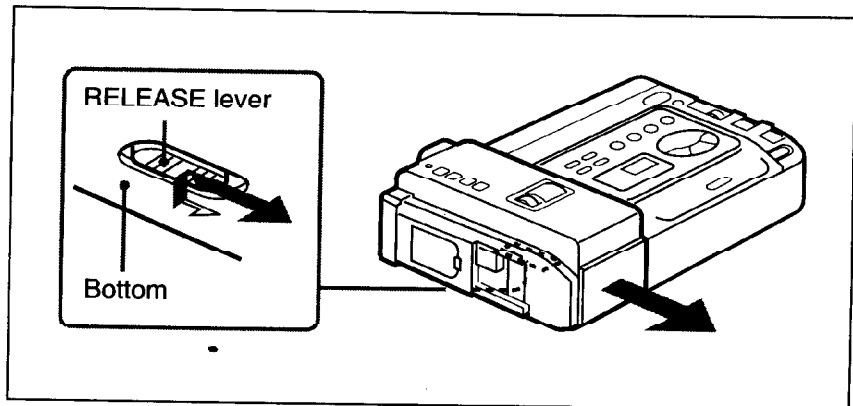

Note

When this adaptor is not connected to the Video Walkman, be sure to attach the left side cover to the Video Walkman to protect the exposed connecting sections.

Connecting a Monitor to the Video Walkman

The menu operation can be done on the monitor connected to the Video Walkman.

Be sure to connect an appropriate monitor to the Video Walkman.

Refer to the operating instructions coming with the Video Walkman.

If your Video Walkman is equipped with an LCD monitor, the menu operation can be done on this monitor.

Connections

Connecting Video Source Equipment

This adaptor accepts video source equipment (such as a video camera) of the following types:

- A video camera having a multi-connector that matches the multi-connector of this adaptor
- A video camera (or other video equipment) with S-video output
- A video camera (or other video equipment) with composite video output

Connecting a video camera having a multi-connector

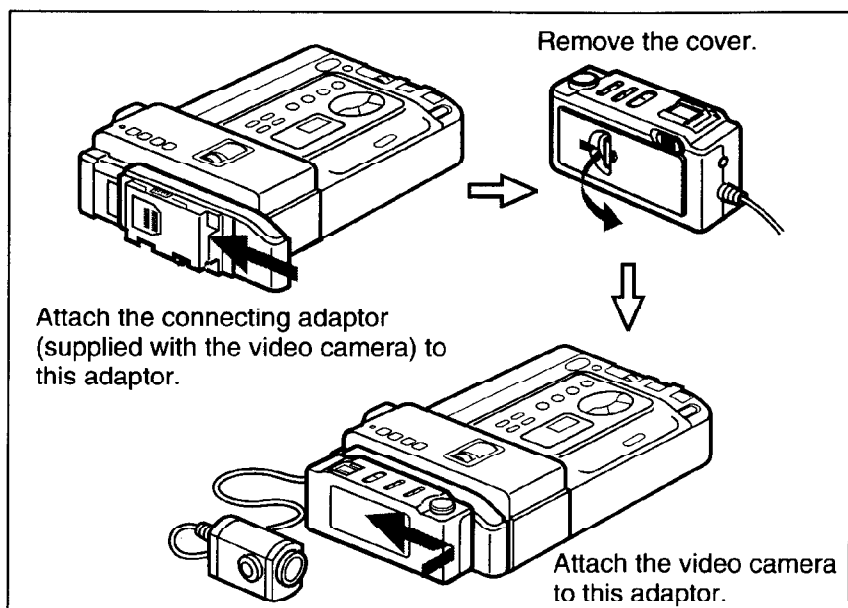

Connecting video source equipment with S-video output/composite video output

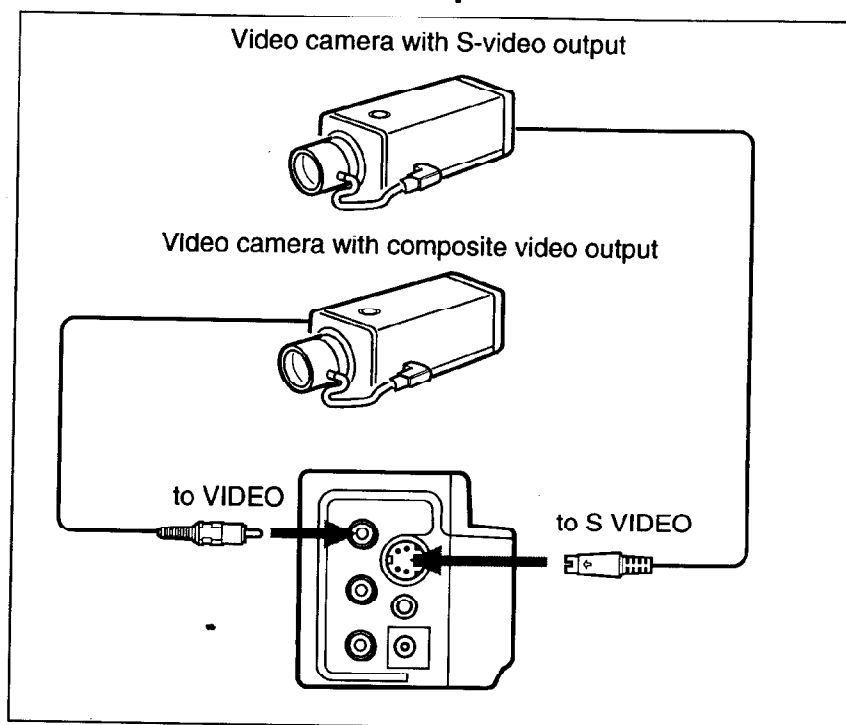

Setting the INPUT SELECT switch

After connecting video source equipment, set the INPUT SELECT switch on this adaptor to the appropriate position according to the type of the video source connected.

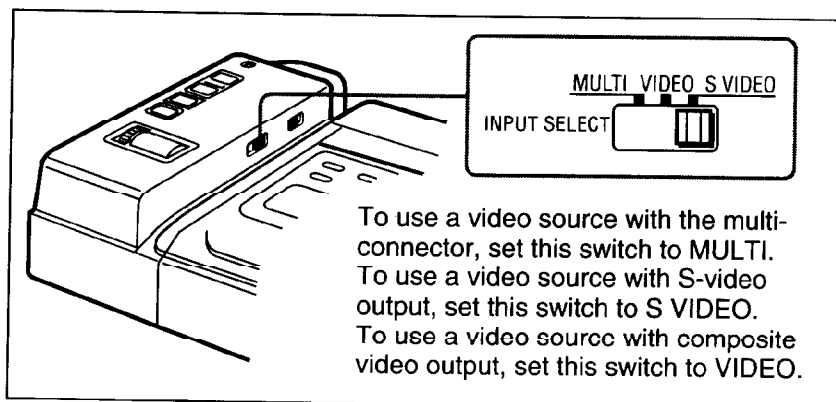

Note

If you set the INPUT SELECT switch to MULTI while nothing is connected to the multi-connector, the S-video input will be selected.

Connections

Connecting Audio Source Equipment

You can connect audio output terminals of the video camera to this adaptor.

You can connect, instead of a video camera as an audio source, a microphone or another audio source equipment.

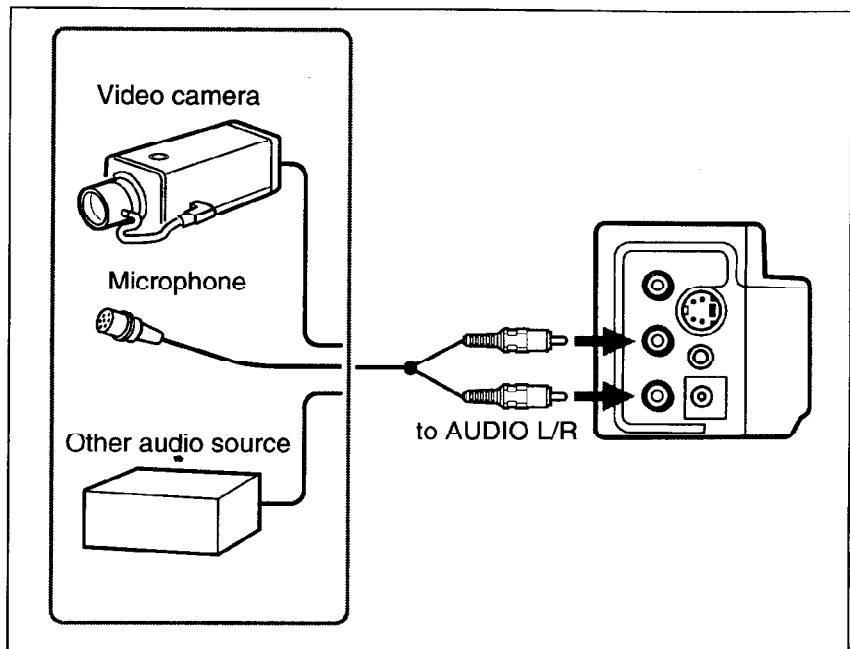

Note

Set the type of the audio source connected to the AUDIO L/R jacks using the OPTIONAL SETUP menu. (See page 22.)

Connecting Alarm Equipment

You can connect an external alarm sensor (an infrared sensor, a motion detector, etc.) to input alarm signals which are considered as triggers for alarm recordings.

If you want to remotely monitor the recording status, you can connect equipment to receive status signals from this adaptor. Use the **OPTIONAL SETUP** menu to select the type of the status signal to be used. (See page 22.)

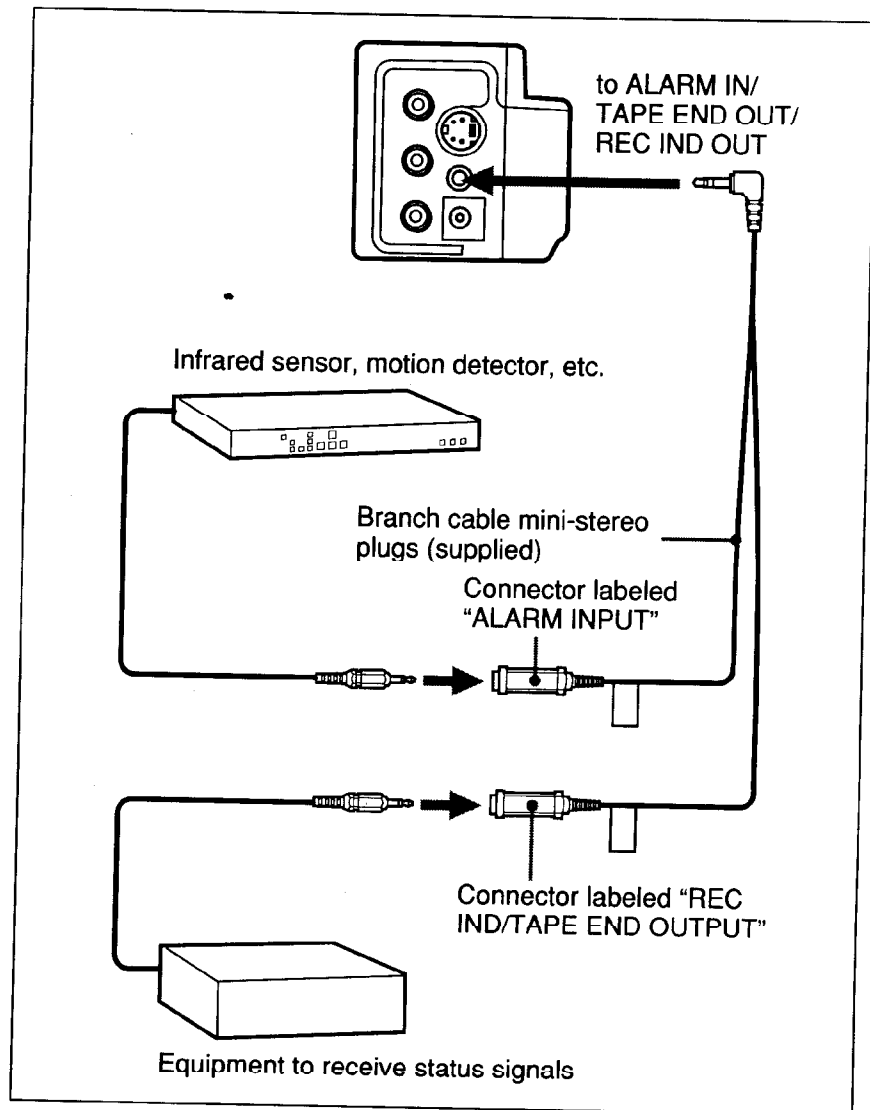

Setting the Clock and the Clock Display Position

You can set the clock and the clock display position so that the date and time are superimposed on the monitor screen connected to the Video Walkman.

You can select the time indication between 12-hour and 24-hour formats.

Moreover, you can also select the date format from among Month/Day/Year, Day/Month/Year, and Year/Month/Day.

Before setting

Check the following points:

- Is the lithium battery installed correctly? (See page 8.)
- Is this adaptor connected to the Video Walkman correctly? (See page 10.)
- Is this adaptor connected to the power source correctly? (See page 16.)
- Is the POWER switch on this adaptor set to ON?

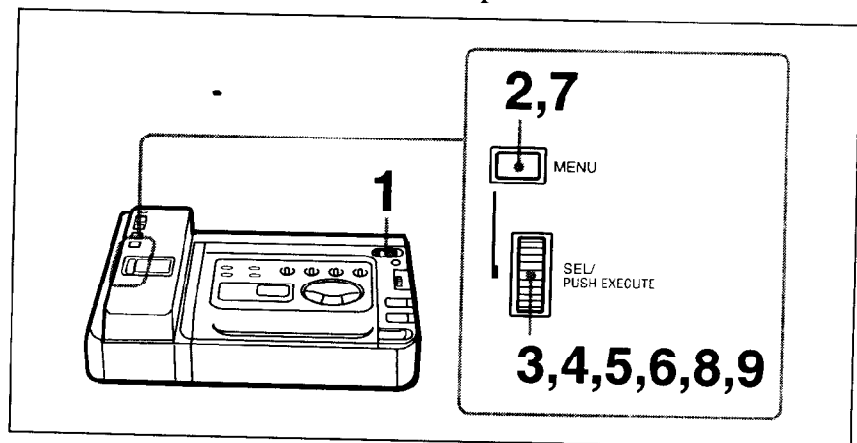

Example: Set to 1:15PM, July 4, 1998

- 1** Turn on the Video Walkman.

The POWER lamp of the Video Walkman lights up. This adaptor turns on simultaneously. (If this is the first time you turn on this adaptor after connecting it to the Video Walkman, the CLOCK SETUP menu appears automatically. Go to step 4.)

(Continued)

Setting the Clock and the Clock Display Position

2 Press MENU.

The MENU screen appears on the monitor connected to the Video Walkman.

```
LOG LIST
REC MODE SETUP
TIMER SETUP
CLOCK SETUP
OPTIONAL SETUP
```

3 Roll SEL/PUSH EXECUTE up or down to select CLOCK SETUP (CLOCK SETUP will be highlighted), and press SEL/PUSH EXECUTE.

The CLOCK SETUP menu appears.

```
CLOCK SETUP
DATE
JAN/ 1/1998 THU 12:00AM

HOURS 12HOURS
CALENDAR MONTH/DAY/YEAR
POSITION
DISPLAY ON
ALARM ON
RETURN
```

4 Set the month, day, and year. Press SEL/PUSH EXECUTE to select the item, roll SEL/PUSH EXECUTE up or down until the desired number appears, and press SEL/PUSH EXECUTE to decide.

The day of the week is automatically displayed.

```
CLOCK SETUP
DATE
JUL/ 4/1998 SAT 12:00AM

HOURS 12HOURS
CALENDAR MONTH/DAY/YEAR
POSITION
DISPLAY ON
ALARM ON
RETURN
```

- 5** Set the hour and minute.
Press SEL/PUSH EXECUTE to select the item, roll SEL/PUSH EXECUTE up or down until the desired number appears, and press SEL/PUSH EXECUTE to decide.

Be sure to set AM and PM correctly.

```
CLOCK SETUP
DATE
  JUL/ 4/1998 SAT 1:15PM
HOURS    12HOURS
CALENDAR MONTH/DAY/YEAR
POSITION
DISPLAY  ON
ALARM    ON
RETURN
```

- 6** Roll SEL/PUSH EXECUTE down to select RETURN, and press SEL/PUSH EXECUTE.

The MENU screen resumes.

(The clock starts as soon as you roll SEL/PUSH EXECUTE.)

- 7** If you want to change the settings concerning the clock, go to step **8**; otherwise press MENU to return to the normal screen.

- 8** Resume the CLOCK SETUP menu.
Roll SEL/PUSH EXECUTE up or down to select CLOCK SETUP, and press SEL/PUSH EXECUTE.

```
CLOCK SETUP
DATE
  JUL/ 4/1998 SAT 1:15PM
HOURS    12HOURS
CALENDAR MONTH/DAY/YEAR
POSITION
DISPLAY  ON
ALARM    ON
RETURN
```

HOURS

The built-in clock of this adaptor shows the time in 12-hour format, but you can change it to 24-hour format if you wish. In 12-hour format, 12:00AM stands for midnight and 12:00PM for noon.

In the CLOCK SETUP menu, roll SEL/PUSH EXECUTE up or down to select HOURS, and press SEL/PUSH EXECUTE to select the item. Roll SEL/PUSH EXECUTE up or down to select 12HOURS (12-hour format) or 24HOURS (24-hour format), and press SEL/PUSH EXECUTE to decide.

(Continued)

Setting the Clock and the Clock Display Position

CALENDAR

In the **CLOCK SETUP** menu, roll **SEL/PUSH EXECUTE** up or down to select **CALENDAR**, and press **SEL/PUSH EXECUTE** to select the item. Roll **SEL/PUSH EXECUTE** up or down to select **MONTH/DAY/YEAR**, **DAY/MONTH/YEAR** or **YEAR/MONTH/DAY**, and press **SEL/PUSH EXECUTE** to decide.

POSITION

In the **CLOCK SETUP** menu, roll **SEL/PUSH EXECUTE** up or down to select **POSITION**, and press **SEL/PUSH EXECUTE** to select the item. Roll **SEL/PUSH EXECUTE** up or down to select the desired clock position, and press **SEL/PUSH EXECUTE** to decide.

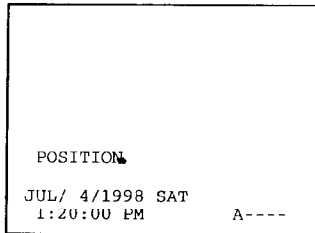

The clock position changes as follows:

Lower left ↔ Upper left ↔ Upper, all in one line



Lower, all in one line ↔ Lower right ↔ Upper right

DISPLAY

In the **CLOCK SETUP** menu, roll **SEL/PUSH EXECUTE** up or down to select **DISPLAY**, and press **SEL/PUSH EXECUTE** to select the item. Roll **SEL/PUSH EXECUTE** up or down to select **ON** or **OFF**, and press **SEL/PUSH EXECUTE** to decide.

ON: The clock is displayed.

OFF: The clock is not displayed.

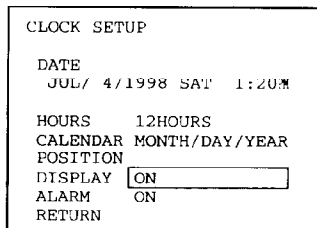

ALARM

In the **CLOCK SETUP** menu, roll **SEL/PUSH EXECUTE** up or down to select **ALARM**, and press **SEL/PUSH EXECUTE** to select the item. Roll **SEL/PUSH EXECUTE** up or down to select **ON** or **OFF**, and press **SEL/PUSH EXECUTE** to decide.

ON: The alarm number is displayed in normal mode and while an alarm recording is being made.

OFF: The alarm number is not displayed. However, the alarm number is counted and retained in the memory.

CLOCK SETUP	
DATE	JUL/ 4/1998 SAT 1:20M
HOURS	12HOURS
CALENDAR	MONTH/DAY/YEAR
POSITION	
DISPLAY	ON
ALARM	ON
RETURN	

- 9 Roll **SEL/PUSH EXECUTE** up or down to select **RETURN**, and press **SEL/PUSH EXECUTE**.

The **MENU** screen resumes.

- 10 Press **MENU**.

The normal screen resumes.

To resume the **MENU** screen

Press **MENU**.

Notes on the built-in clock

- If the lithium battery is not installed, the clock will be reset each time you turn off this adaptor and turn it on back again.
- The built-in clock may not work correctly due to temperature change and so on. Check the clock occasionally and set it again if necessary.

Note on the clock display position

According to the camera or video source, the clock indication may be distorted at the upper part of the screen. In this case, select the lower position for clock display.

Optional Setting Up

You can select the type of status signal (tape end out or recording indication out) using the OPTIONAL SETUP menu. With this menu, you can also specify the type of the audio source equipment connected to this adaptor (line input or microphone).

Setting the OPTIONAL SETUP Menu

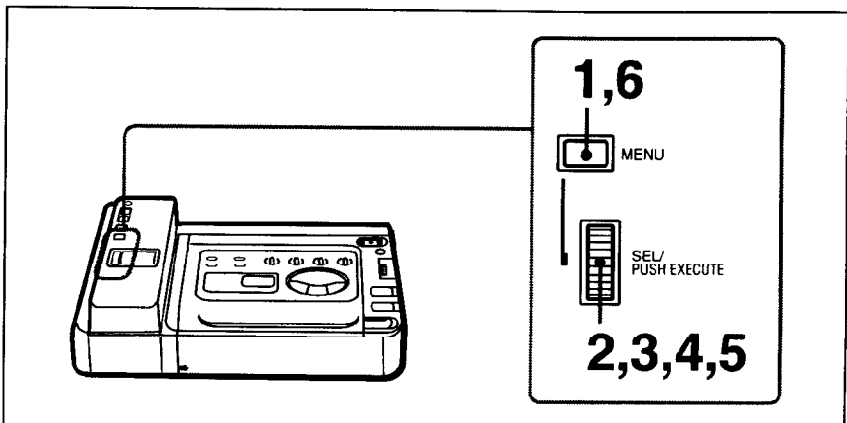

- 1 Press MENU.

The MENU screen appears on the monitor connected to the Video Walkman.

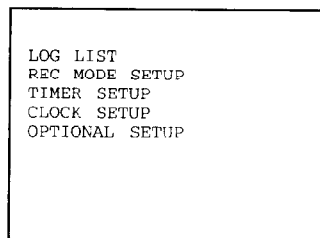

- 2 Roll SEL/PUSH EXECUTE up or down to select OPTIONAL SETUP, and press SEL/PUSH EXECUTE.

The OPTIONAL SETUP menu appears.

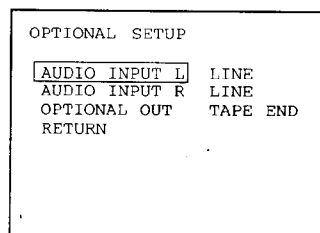

- 3** Select the type of the alarm output signal.
Roll SEL/PUSH EXECUTE up or down to select OPTIONAL OUT, and press SEL/PUSH EXECUTE to select the item. Roll SEL/PUSH EXECUTE up or down to select TAPE END or REC, and press SEL/PUSH EXECUTE to decide.

TAPE END (tape end out): A signal is output when the tape reaches its end while a program recording is made.

REC (recording indication out): A signal is output while a program recording is made.

OPTIONAL SETUP	
AUDIO INPUT L	LINE
AUDIO INPUT R	LINE
OPTIONAL OUT	TAPE END
RETURN	

- 4** Set the type of the audio source for the left and right channels independently.
Roll SEL/PUSH EXECUTE up or down to select AUDIO INPUT L or AUDIO INPUT R, and press SEL/PUSH EXECUTE to select the item. Roll SEL/PUSH EXECUTE up or down to select LINE or MIC, and press SEL/PUSH EXECUTE to decide.

LINE: When an audio source is connected to the AUDIO L or AUDIO R jack.

MIC: When a microphone is connected to the AUDIO L or AUDIO R jack.

When you do not connect any audio source, select LINE. If you select MIC, noise may be picked up.

OPTIONAL SETUP	
AUDIO INPUT L	LINE
AUDIO INPUT R	LINE
OPTIONAL OUT	TAPE END
RETURN	

(Continued)

Optional Setting Up

- 5** Roll SEL/PUSH EXECUTE up or down to select RETURN, and press SEL/PUSH EXECUTE.

The MENU screen resumes.

- 6** Press MENU.

The normal screen resumes.

To resume the MENU screen

Press MENU.

Setting the Program Recording Conditions

What is the Program Recording?

This adaptor gives you a choice of any one of the following three program recording modes:

ALARM mode (see page 28)

When an alarm signal is input to this adaptor, the Video Walkman starts recording automatically for a specified duration with its alarm number and the date and time displayed on the monitor. This adaptor considers an alarm signal input through the ALARM IN/TAPE END OUT/REC IND OUT jack of this adaptor as a trigger for alarm recording. (A power failure is also considered as a trigger.) The time and cause of an alarm signal is stored in the memory of this adaptor with the alarm number so that you can refer to them later on. This is called the alarm mode.

CONTI REC (Continuous Recording) mode (see page 33)

The Video Walkman keeps recording and the buttons on the Video Walkman are locked. Therefore the recording does not stop even when you press (stop) or **||** (pause) on the Video Walkman by mistake.

When an alarm signal is input in CONTI REC mode, the date/time and cause of the alarm signal is memorized in the alarm list. While the alarm signal is input, the alarm number is superimposed and recorded on the tape.

TIMER mode (see page 35)

The Video Walkman performs program recording according to the preset timer programs. You can preset up to 6 events over one month to this adaptor. In each event, you can set the date, the starting and ending time, and the program recording mode; ALM (alarm) or CREC (continuous recording). Moreover, you can perform the same program recording on every day or on a specific day of every week.

After completing the settings, be sure to check whether the settings are correct or not by pressing CHECK to see the CHECK screen. (See page 42.)

When the settings are correct, press PGM/LIST REC ON/OFF to enter program recording mode. (See page 40.)

Setting the Program Recording Conditions

Selecting the REC MODE SETUP Menu

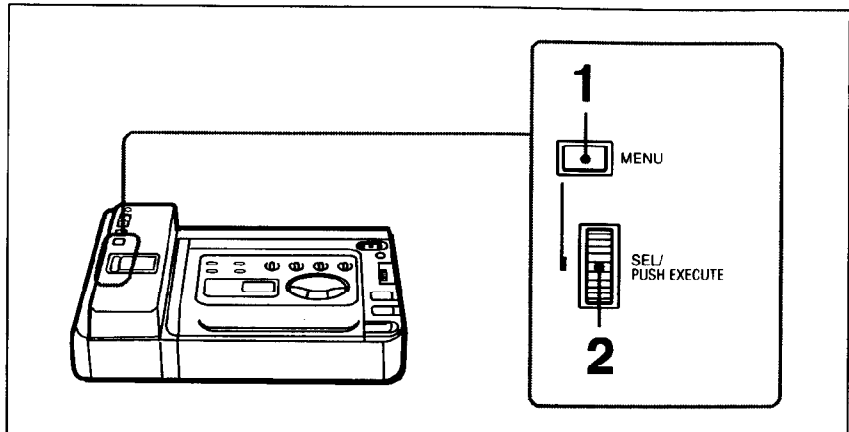

1 Press MENU.

The MENU screen appears on the monitor connected to the Video Walkman.

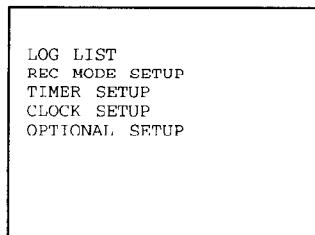

2 Roll SEL/PUSH EXECUTE up or down to select REC MODE SETUP, and press SEL/PUSH EXECUTE.

The REC MODE SETUP menu appears.

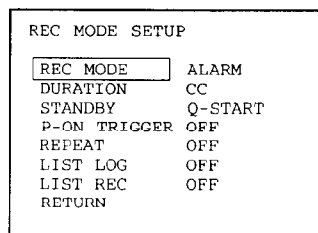

Setting of Each Item in the REC MODE SETUP Menu

Menu item	Description
REC MODE	To select the program recording mode. ALARM: See page 28. CONTI REC: See page 33. TIMER: See page 35.
DURATION	To set how long a recording should be made after receiving an alarm signal CC: The Video Walkman keeps recording as long as an alarm signal is input. TOGGLE: Video Walkman repeats starting/stopping the program recording each time an alarm signal is input. 10S/20S/30S (10/20/30 seconds): The Video Walkman records for about 10, 20 or 30 seconds after an alarm signal is input. 1M/2M/3M/5M/10M/20M/30M (1 to 30 minutes): The Video Walkman records for about 1, 2, 3, 5, 10, 20 or 30 minute(s) after an alarm signal is input. 1H (1 hour): The Video Walkman records for about 1 hour after an alarm signal is input. TAPE END: The Video Walkman records until the tape reaches its end, once an alarm signal is input.
STANDBY	To select the stand by status (When you select CONTI REC in REC MODE, you cannot set this item.) Q-START (quick start): The Video Walkman waits for an alarm signal in recording pause mode. However, if there is no alarm signal for about 5 minutes, the Video Walkman waits in stop mode. POWER SAVE: The Video Walkman turns off. When an alarm signal is input or at the starting time of the TIMER setting, the Video Walkman turns on and starts recording. ALM OFF (alarm off): (only when you select TIMER in REC MODE SETUP) The Video Walkman turns off until the starting time of the TIMER setting comes. Even if an alarm signal is input, the Video Walkman ignores it and the power remains off.
P-ON TRIGGER	To decide what is considered as an alarm signal ON: A power-on signal of this adaptor is considered as an alarm signal. OFF: A power-on signal of this adaptor is not considered as an alarm signal. If DURATION is set to CC or TOGGLE and when recording starts by a power on signal, recording will continue for about 20 seconds.
REPEAT	To decide what to do when the tape reaches its end while a program recording is made. ON: The tape rewinds to the beginning and starts program recording again. Note that this setting erases the previous recordings. OFF-ALM (off with alarm): The tape stops when an alarm recording is made. When no alarm recording is made, the tape rewinds to the beginning and starts program recording again. OFF: The tape stops.

Setting the Program Recording Conditions

Menu item	Description
LIST LOG	To decide whether or not the date/time and cause of an alarm signal is memorized in the log list. ON: The date/time and cause of an alarm signal are memorized in the alarm list. OFF: The date/time and cause of an alarm signal are not memorized in the alarm list.
LIST REC	To decide whether or not you record the log list on the tape automatically. ON: The alarm list is recorded on the tape whenever you exit the program recording mode. OFF: The alarm list is not recorded automatically.

Setting the ALARM Recording Mode

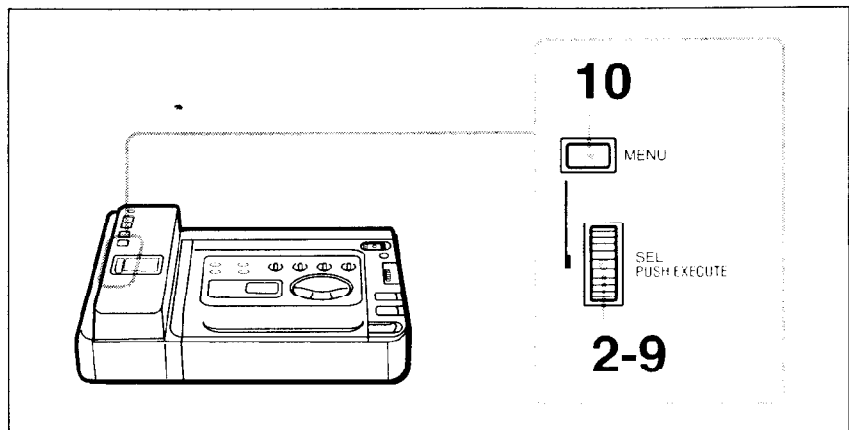

- 1 Select the REC MODE SETUP menu.

See page 26 for how to select the menu.

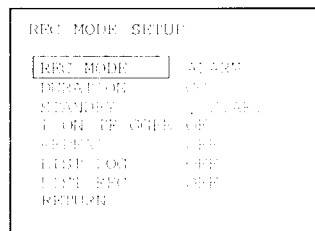

- 2** Set the program recording mode to ALARM.
Roll SEL/PUSH EXECUTE up or down to select REC MODE, and press SEL/PUSH EXECUTE to select the item. Roll SEL/PUSH EXECUTE up or down to select ALARM, and press SEL/PUSH EXECUTE to decide.

REC MODE SETUP	
REC MODE	<input type="text" value="ALARM"/>
DURATION	CC
STANDBY	Q-START
P-ON TRIGGER	OFF
REPEAT	OFF
LIST LOG	OFF
LIST REC	OFF
RETURN	

- 3** Set the duration of a recording.
Roll SEL/PUSH EXECUTE up or down to select DURATION, and press SEL/PUSH EXECUTE to select the item. Roll SEL/PUSH EXECUTE up or down to select CC, TOGGLE, 10S, 20S, 30S, 1M, 2M, 3M, 5M, 10M, 20M, 30M, 1H, or TAPE END (S stands for second, M for minute, and H for hour), and press SEL/PUSH EXECUTE to decide.

REC MODE SETUP	
REC MODE	ALARM
DURATION	<input type="text" value="TAPE END"/>
STANDBY	Q-START
P-ON TRIGGER	OFF
REPEAT	OFF
LIST LOG	OFF
LIST REC	OFF
RETURN	

- 4** Set STANDBY to select the stand-by status.
Roll SEL/PUSH EXECUTE up or down to select STANDBY, and press SEL/PUSH EXECUTE to select the item. Roll SEL/PUSH EXECUTE up or down to select Q-START (quick start) or POWER SAVE (power save), and press SEL/PUSH EXECUTE to decide. (ALM OFF (alarm off) is only for TIMER recording mode.)

REC MODE SETUP	
REC MODE	ALARM
DURATION	TAPE END
STANDBY	<input type="text" value="POWER SAVE"/>
P-ON TRIGGER	OFF
REPEAT	OFF
LIST LOG	OFF
LIST REC	OFF
RETURN	

(Continued)

Setting the Program Recording Conditions

- 5** Set P-ON TRIGGER to select whether or not a power on signal of this adaptor is considered as an alarm signal. Roll SEL/PUSH EXECUTE up or down to select P-ON TRIGGER, and press SEL/PUSH EXECUTE to select the item. Roll SEL/PUSH EXECUTE up or down to select ON or OFF, and press SEL/PUSH EXECUTE to decide.

```
REC MODE SETUP
REC MODE      ALARM
DURATION      TAPE EMD
STANDBY       POWER SAVE
P-ON TRIGGER  ON
REPEAT        OFF
LIST LOG      OFF
LIST REC      OFF
RETURN
```

- 6** Set REPEAT to decide what to do when the tape reaches its end during program recording. Roll SEL/PUSH EXECUTE up or down to select REPEAT, and press SEL/PUSH EXECUTE to select the item. Roll SEL/PUSH EXECUTE up or down to select ON, OFF-ALM (off with alarm), or OFF, and press SEL/PUSH EXECUTE to decide.

```
REC MODE SETUP
REC MODE      ALARM
DURATION      TAPE EMD
STANDBY       POWER SAVE
P-ON TRIGGER  ON
REPEAT        ON
LIST LOG      OFF
LIST REC      OFF
RETURN
```

- 7** Set LIST LOG to decide whether or not the date/time and cause of an alarm signal is memorized in the log list. Roll SEL/PUSH EXECUTE up or down to select LIST LOG, and press SEL/PUSH EXECUTE to select the item. Roll SEL/PUSH EXECUTE up or down to select ON or OFF, and press SEL/PUSH EXECUTE to decide.

```
REC MODE SETUP
REC MODE      ALARM
DURATION      TAPE EMD
STANDBY       POWER SAVE
P-ON TRIGGER  ON
REPEAT        ON
LIST LOG      ON
LIST REC      OFF
RETURN
```

- 8** Set LIST REC to decide whether or not you record the log list when exiting program recording mode.
Roll SEL/PUSH EXECUTE up or down to select LIST REC, and press SEL/PUSH EXECUTE to select the item.
Roll SEL/PUSH EXECUTE up or down to select ON or OFF, and press SEL/PUSH EXECUTE to decide.

REC MODE SETUP	
REC MODE	ALARM
DURATION	TAPE EMD
STANDBY	POWER SAVE
P-ON TRIGGER	ON
REPEAT	ON
LIST LOG	ON
LIST REC	<input type="checkbox"/>
RETURN	

- 9** Roll SEL/PUSH EXECUTE up or down to select RETURN, and press SEL/PUSH EXECUTE.

The MENU screen resumes.

- 10** Press MENU.

The normal screen resumes.

To resume the MENU screen

Press MENU.

Note on the automatic repeat function

When you select ON in REPEAT, this setting may erase the previous alarm recordings.

Note on the length of alarm signals

When you select ON in P-ON TRIGGER, alarm signals less than 100 msec are not detected.

Note on the recording timing

When an alarm signal is input, the exact time of the alarm signal (or the power failure) is memorized in the alarm list. However, the actual recording starts a little later to hook up the Video Walkman for recording.

When you select Q-START, it takes the time needed to enter the recording mode from the recording pause mode. Note that the stop mode will be entered if recording does not start within 5 minutes while the Video Walkman is in the recording pause mode.

When you select POWER SAVE, it takes about 10 seconds to start recording.

Setting the Program Recording Conditions

Notes on the alarm DURATION

- When you select CC and the alarm signal length is considerably short, recording may not be done.
- The values of the DURATION stand for the approximate length of the recording when an alarm signal is input. Therefore, the values may differ according to the stand-by status, environment, etc.

When frequent power failures are expected

The recording cued by a power failure may erase the previous recording slightly. We recommend setting the DURATION longer than 20 seconds.

When another alarm signal is input while an alarm recording is being made

The recording is prolonged for the duration of the alarm signal that was input later.

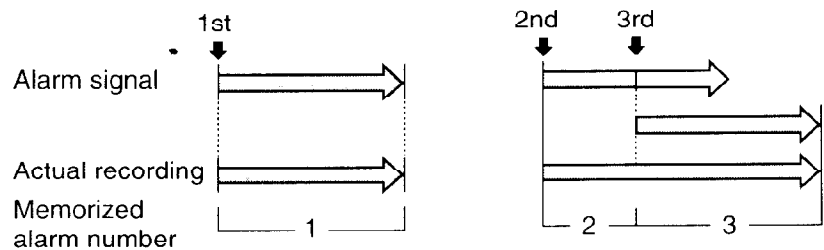

When an alarm signal is input while the tape is rewinding (when REPEAT is set to ON in step 6)

The date/time and cause of the alarm signal is memorized in the log list with its alarm number. If the tape rewinds to the beginning within the alarm recording duration, the Video Walkman records for the rest of the alarm recording duration.

When an alarm signal is input in emergency mode

This adaptor enters emergency mode with the REC ON/OFF lamp flashing rapidly when:

- The tape reaches its end with OFF selected in REPEAT. In this case, a signal is output from the ALARM IN/TAPE END OUT/ REC IND OUT jack. You can exit emergency mode by pressing PGM/LIST REC ON/OFF.
- Moisture condenses inside the Video Walkman.
- This adaptor malfunctions.

Even in these cases, the date/time and cause of the alarm signal is memorized in the log list.

This function does not work during a power failure.

Setting the CONTI REC (Continuous Recording) Mode

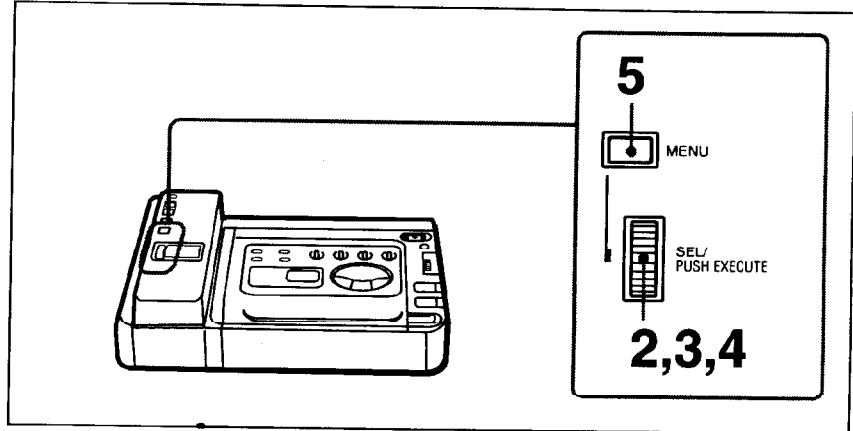

- 1 Select the REC MODE SETUP menu.

See page 26 for how to select the menu.

REC MODE SETUP	
REC MODE	ALARM
DURATION	CC
STANDBY	Q-START
P-ON TRIGGER	OFF
REPEAT	OFF
LIST LOG	OFF
LIST REC	OFF
RETURN	

(Continued)

Setting the Program Recording Conditions

- 2 Set the program recording mode to CONTI REC.
Roll SEL/PUSH EXECUTE up to select REC MODE, and press SEL/PUSH EXECUTE to select the item. Roll SEL/PUSH EXECUTE up or down to select CONTI REC, and press SEL/PUSH EXECUTE to decide.

“----” appears in the STANDBY column.

REC MODE SETUP	
REC MODE	CONTI REC
DURATION	CC
STANDBY	----
P-ON TRIGGER	OFF
REPEAT	OFF
LIST LOG	OFF
LIST REC	OFF
RETURN	

- 3 Check other items and change the settings if necessary.
(See pages 29 to 31.)
- 4 Roll SEL/PUSH EXECUTE down to select RETURN, and press SEL/PUSH EXECUTE.

The MENU screen resumes.

- 5 Press MENU.

The normal screen resumes.

To resume the MENU screen
Press MENU.

Note on the stand-by status

You cannot set STANDBY in the CONTI REC mode.

Setting the TIMER Recording Mode and Timer Programs

After setting the TIMER recording mode in the REC MODE SETUP menu, you must preset timer programs in the TIMER SETUP menu.

Make the timer programs as you wish, for example, according to the opening and closing time of your store, etc.

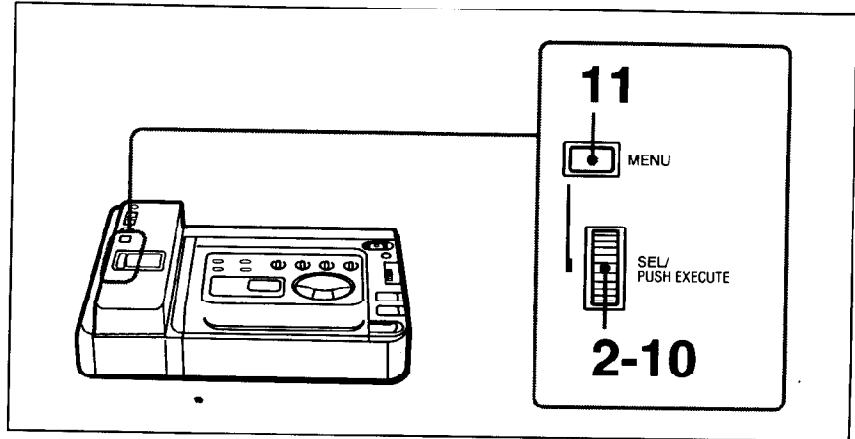

- 1 Select the REC MODE SETUP menu.

See page 26 for how to select the menu.

REC MODE SETUP	
REC MODE	ALARM
DURATION	CC
STANDBY	Q-START
P-ON TRIGGER	OFF
REPEAT	OFF
LIST LOG	OFF
LIST REC	OFF
RETURN	

Set the program recording mode to TIMER

Roll SEL/PUSH EXECUTE up or down to select RE MODE, and press SEL/PUSH EXECUTE to select th item. Roll SEL/PUSH EXECUTE up or down to selec TIMER, and press SEL/PUSH EXECUTE to decide

REC MODE SETU	
REC MODE	TIME
DURATION	C
STANDBY	Q-STAR
P-ON TRIGGER	OF
REPEAT	OF
LIST LOG	OF
LIST REC	OF
RETUR	

(Continued)

Setting the Program Recording Conditions

3 Check other items and change the settings if necessary.
(See pages 29 to 31.)

4 Roll SEL/PUSH EXECUTE up or down to select RETURN, and press SEL/PUSH EXECUTE.

The MENU screen resumes.

```
LOG LIST
REC MODE SETUP
TIMER SETUP
CLOCK SETUP
OPTIONAL SETUP
```

Roll SEL/PUSH EXECUTE up or down to select TIME SETUP, and press SEL/PUSH EXECUTE

The TIMER SETUP menu appears

```
TIMER  SETU          JUL/ 4/199 SA
                        1:30:00P
  DAT      O      OF  MOD
-----  ---:  ---:-----
-----  ---:  ---:-----
-----  ---:  ---:-----
-----  ---:  ---:-----
-----  ---:  ---:-----
RETUR
```

Roll SEL/PUSH EXECUTE up or down to select the line

Set the date, starting time, and ending time

Press SEL/PUSH EXECUTE to select the item. Roll SEL/PUSH EXECUTE up or down to the desired date or time appears, and press SEL/PUSH EXECUTE to decide.

```
TIMER  SETUP          JUL/ 4/1998 SAT
                        1:30:00PM
  DATE    ON      OFF  MODE
MON-FRI PM7:30 AM9 :00]-----
-----  ---:  ---:-----
-----  ---:  ---:-----
-----  ---:  ---:-----
-----  ---:  ---:-----
RETURN
```

To change an item which is already set

Press SEL/PUSH EXECUTE to select the item. Roll SEL/PUSH EXECUTE up or down to change it, and press SEL/PUSH EXECUTE to decide.

- 8** Set MODE to decide what to do within the designated period.

Press SEL/PUSH EXECUTE to select the MODE column, and roll SEL/PUSH EXECUTE up or down to select CREC or ALM, and press SEL/PUSH EXECUTE to decide.

CREC: The Video Walkman performs the CREC (continuous recording) within the period from the starting time and the ending time.

ALM: The Video Walkman performs an ALM (alarm) recording as designated in the REC MODE SETUP menu within the period from the starting time and the ending time.

```
TIMER SETUP
      JUL/ 4/1998SAT
      1.30.00PM
DATE  ON   OFF  MODE
MON-FRI #7:30 #9:00 [ALM]
-----
-----
-----
-----
-----
RETURN
```

- 9** Press SEL/PUSH EXECUTE to store the setting. If you want to make another setting, roll SEL/PUSH EXECUTE down to select the next line, and repeat steps 7 and 8.

- 10** Roll SEL/PUSH EXECUTE up or down to select RETURN, and press SEL/PUSH EXECUTE.

The MENU screen resumes.

- 11** Press MENU.

The normal screen resumes.

To resume the MENU screen

Press MENU.

To clear the timer settings

Roll SEL/PUSH EXECUTE up or down to select the setting line to be cleared and press CLEAR.

The setting is cleared and “----- --:-- --:-- --:-- -----” indication resumes.

Setting the Program Recording Conditions

Note on the stand-by status

In the STANDBY column in the REC MODE SETUP menu, you can select Q-START (quick start), POWER SAVE, or ALM OFF (alarm off) to set the stand-by status before the starting time preset in the TIMER SETUP menu. (When the Q-START is selected, if recording does not start within 5 minutes, stop mode will be entered.)

Note on the timer setting which works only on a specific day

The timer setting will be cleared after the starting time has passed. However, the Video Walkman does not exit the program recording mode even if all the timer setting are cleared. If you want to exit the program recording mode, press PGM/LIST REC ON/OFF.

Every week recording and every day recording

You can preset to perform the same program recording every day or on a specific day of every week. When you select the date, roll SEL/PUSH EXECUTE up or down, and the indication changes as follows:

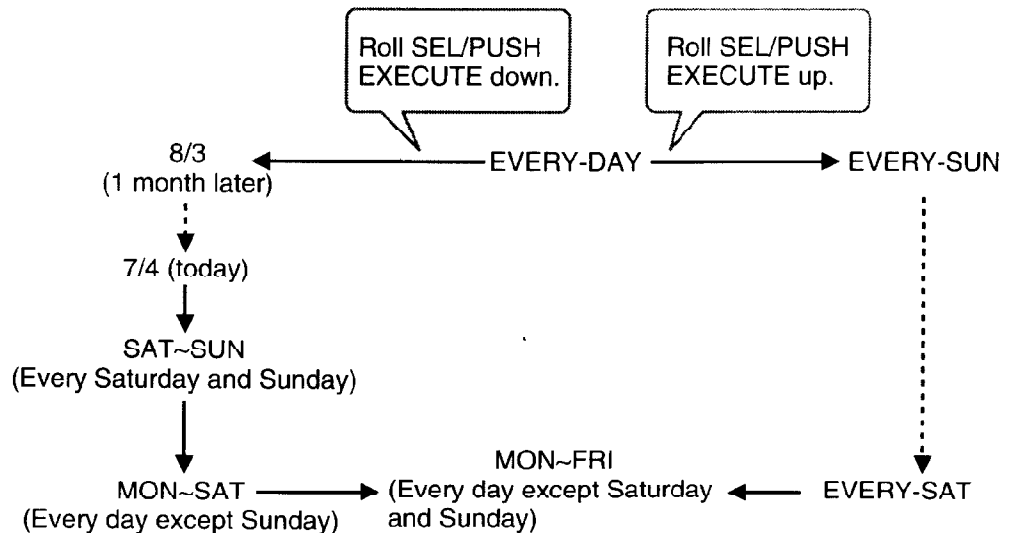

When you press PGM/LIST REC ON/OFF after the preset starting time

The Video Walkman enters the program recording stand-by mode, not the program recording mode.

Example

Preset **TIMER** setting: **EVERYDAY**, from 7:00AM to 11:00PM, **CREC** mode

If you press **PGM REC ON/OFF** at 9:00AM, July 4, the Video Walkman enters the program recording stand-by mode and actually starts the program recording at 7:00AM, July 5.

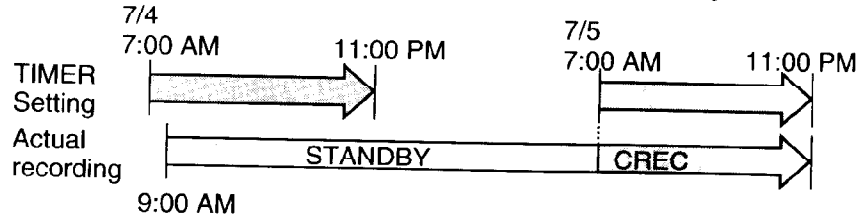

If you want to perform a program recording today, make an additional **TIMER** setting as follows:

Additional **TIMER** setting: 7/4 (today), from 9:05 AM (a little later than the current time) to 11:00 PM, **CREC** mode

When the settings of **TIMER recordings overlap**

- **If the starting time of one setting comes before the recording of the other setting ends**

The recording of setting 2 starts before setting 1 ends.

- **If the starting time of two settings are the same**

The setting which is preset on the upper line in the **TIMER SETUP** menu will be recorded and the other setting will be canceled.

Example

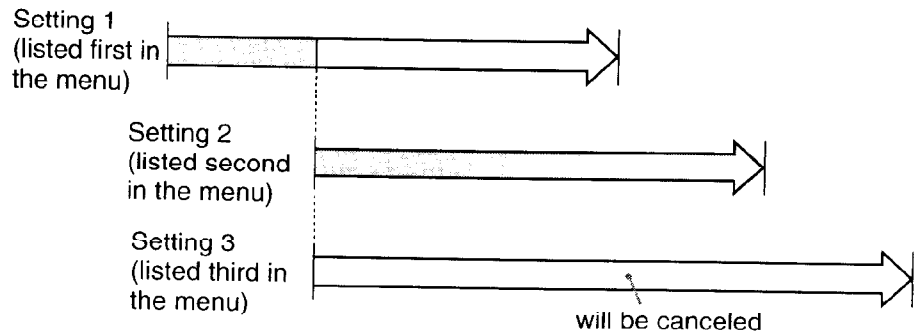

 : portions to be recorded

Setting 1: The recording will stop before the designated ending time.

Setting 2: The recording will be performed completely.

Setting 3: The setting will be canceled.

Setting the Program Recording Conditions

When an alarm signal is input in TIMER recording mode

Example

When an alarm signal is input when you set CREC in MODE, and Q-START or POWER SAVE in STANDBY

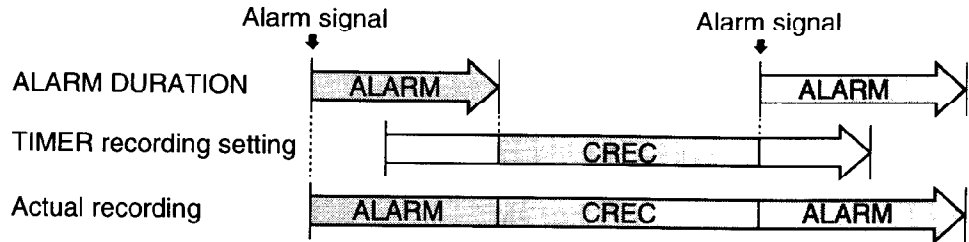

When an alarm signal is input when you set CREC in MODE, and ALM-ON in STANDBY

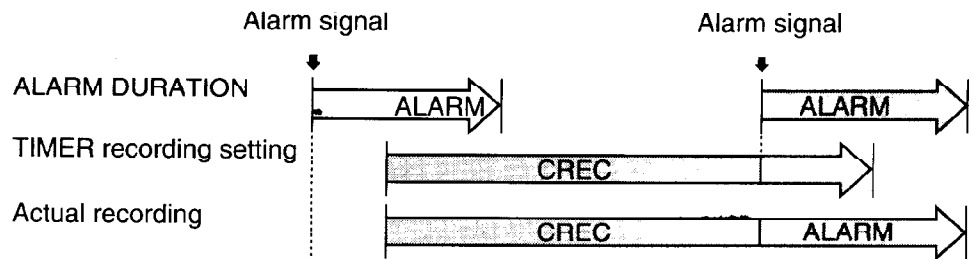

Entering the Program Recording Mode

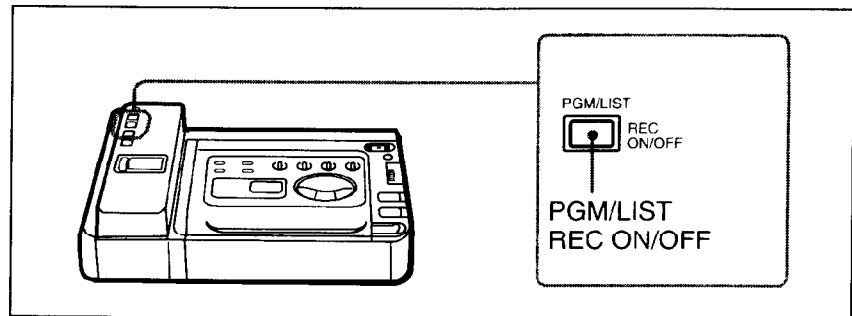

After selecting the program recording mode in the REC MODE SETUP menu and completing the detailed settings in each menu, press PGM/LIST REC ON/OFF.

This adaptor enters stand-by mode with the PGM LIST REC ON/OFF lamp lighting or starts recording with the REC ON/OFF lamp flashing, depending on the program recording mode you have selected.

To exit the program recording mode

If you want to exit the program recording stand-by mode or you want to stop a program recording, press PGM/LIST REC ON/OFF again.

The PGM REC lamp goes off.

Note on video tapes

Before pressing REC ON/OFF, make sure that a tape with its safety tab slid in is inserted in the Video Walkman. If the safety tab is slid out (the red tab window is visible), the Video Walkman does not enter the program recording mode.

Note on the buttons

Excluding the CHECK and PGM LIST REC ON/OFF buttons, the buttons on the Video Walkman and this adaptor are disabled during program recording and program recording stand-by mode.

The CHECK and PGM LIST REC ON/OFF buttons function as follows.

During program recording mode: PGM LIST REC ON/OFF button only

During program recording stand-by mode: Both CHECK and PGM LIST REC ON/OFF buttons

Changing the Settings

1 Press PGM LIST REC ON/OFF to exit the program recording mode.

2 Change the settings as you wish.

Checking the Settings

You can check the setting of this adaptor before you press PGM/LIST REC ON/OFF to start a program recording or during program recording stand-by mode.

The following screen appears when you press CHECK.

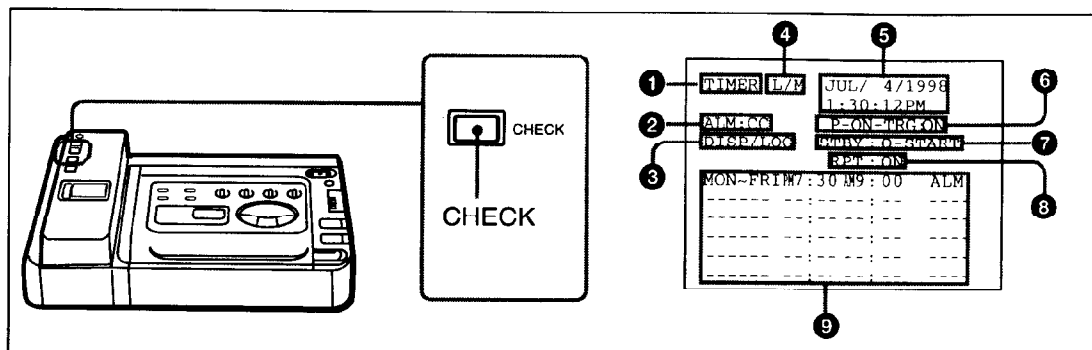

① Setting of program recording mode in the REC MODE SETUP menu

② Setting of DURATION of the REC MODE SETUP menu
T-END stands for TAPE END.

③ Setting of DISPLAY in the CLOCK SETUP sub-menu and LIST LOG in the REC MODE SETUP menu

DISP: The alarm number is displayed on the screen.

LOG: The alarm number is memorized in the log list.

DISP/LOG: The alarm number is displayed on the screen and memorized in the alarm list.

No display: The alarm number is not displayed and not memorized in the log list.

④ Audio input

L stands for line input, and M for microphone input.

For example, L/M means line input level for the left channel and microphone input for the right channel.

⑤ Current date and time

⑥ Setting P-ON TRIGGER of the REC MODE SETUP menu
P-ON-TRG stands for P-ON TRIGGER.

⑦ Setting of STANDBY in the REC MODE SETUP menu (When CREC is selected in REC MODE in the REC MODE SETUP menu, nothing is indicated.)

P-SAVE stands for POWER SAVE.

⑧ Setting of REPEAT in the REC MODE SETUP menu

Nothing is indicated when OFF is selected.

⑨ Settings of the TIMER REC menu

Nothing is indicated when TIMER is not selected for REC MODE in the REC MODE SETUP menu.

Checking the Alarm List

This adaptor memorizes the alarm number (up to 9999) and the date/time and cause of the alarm recordings (first 32 events since you select ON in LIST LOG in the REC MODE SETUP menu) in its memory and displays the list on the monitor. Since one page of the list displays up to 6 lines of the time and cause of the alarm recordings, the list contains 6 pages at its maximum.

1 Press MENU.

The MENU screen appears on the monitor of the Video Walkman.

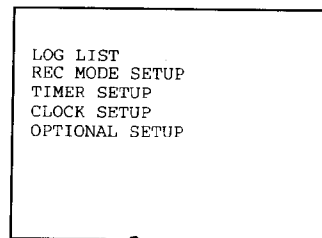

2 Roll SEL/PUSH EXECUTE up or down to select LOG LIST, and press SEL/PUSH EXECUTE.

The LOG LIST appears.

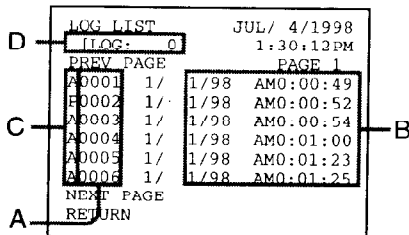

If the list has more than one page, roll SEL/PUSH EXECUTE up or down to select NEXT PAGE and press SEL/PUSH EXECUTE to resume the next page.

To go back to the previous page, roll SEL/PUSH EXECUTE up or down to select PREV PAGE and press SEL/PUSH EXECUTE to resume the next page.

(Continued)

Checking the Alarm List

The list shows:

A: The log number

B: The date and time of the alarm recordings

C: The cause of the alarm recordings

A- the alarm recording caused by an alarm signal

P- the alarm recording caused by a power failure (or indicates a power failure while an alarm recording is made)

D: The total number of alarm signals

- 3** Roll SEL/PUSH EXECUTE down to select RETURN, and press SEL/PUSH EXECUTE.

The MENU screen resumes.

- 4** Press MENU.

The normal screen resumes.

To resume the MENU screen

Press MENU.

To clear the log list

Display the log list and press CLEAR.

The contents of the log list are cleared from the memory of this adaptor.

To record the log list on the tape

Method 1:

Press PGM/LIST REC ON/OFF in normal mode, roll SEL/PUSH EXECUTE down to select LIST REC and press SEL/PUSH EXECUTE.

Method 2:

Select ON in LIST REC in the REC MODE SETUP menu.

The alarm list is automatically recorded on the tape when you exit the program recording mode (excluding that TAPE END is selected for DURATION).

Resuming Playback

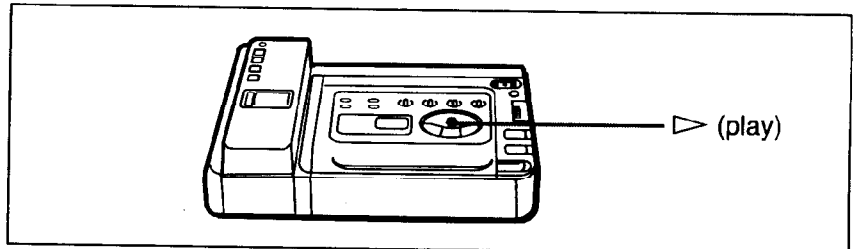

Press  (play) on the Video Walkman with the PGV-250 in normal screen mode.

Troubleshooting

If you have a problem with this adaptor, first check the Video Walkman while referring to the troubleshooting guide in the operation manual of the Video Walkman, then go through the list below. Should the problem persists, consult your Sony dealer.

Symptom	Possible cause and/or corrections
"Backup Battery Low" appears in normal screen mode.	The lithium battery has run down or no lithium battery is installed. ➔ Install a new lithium battery.
The sound is low, distorted, or noisy.	The type of the audio source is not set correctly. ➔ Set the correct type of the audio source in the OPTIONAL SETUP menu.
The program recording does not operate.	<ul style="list-style-type: none"> • The Video Walkman is not in program recording mode. ➔ Press PGM LIST REC ON/OFF so that the REC ON/OFF lamp lights up or flashes. • The clock is not set correctly. ➔ Set the clock correctly. • The safety tab of the cassette is slid out. ➔ Slide the safety tab in. • The desired program recording mode is not selected in REC MODE in the REC MODE SETUP menu. • The TIMER settings overlap or the settings are not correct. ➔ Check the program record setting with the CHECK screen. If the setting is not correct, set it again.
The REC ON/OFF lamp flashes rapidly.	This adaptor is in emergency mode after reaching the tape end during a program recording, when the automatic repeat function is set to OFF, or set to OFF-ALM and there was an alarm signal input. ➔ Press PGM LIST REC ON/OFF to exit program recording mode.
The PGM LIST REC ON/OFF button does not function.	<ul style="list-style-type: none"> • The tape has reached its end. ➔ Use another cassette or rewind the tape. • The write-protect tab of the cassette inserted is set to the write-protect position. ➔ Set the write-protect tab to the opposite position.
This adaptor does not operate.	<ul style="list-style-type: none"> • This adaptor is not connected to the Video Walkman firmly. ➔ Make the connection firmly. • The POWER switch of the adaptor is set to OFF. ➔ Set the POWER switch to ON.
The buttons on the Video Walkman are disabled.	This adaptor is in program recording (stand-by) mode ➔ Set the adaptor to the normal screen mode.

Specifications

Timer section

Clock	Crystal lock
Time indication	Selectable between 12-hour (factory setting) and 24-hour formats

Input/Output

VIDEO	Phono jack (1) 1 Vp-p, 75 ohms, unbalanced, sync negative
AUDIO L/R	Phono jack (2) LINE/MIC selectable LINE: 327 mV (-7.5 dBs) MIC: 0.775 mV (-60 dBs) (0 dBs=0.775 Vrms) Input impedance: more than 47 kilohms

S VIDEO input

S video input jack (1)

ALARM IN/TAPE END OUT/ REC IND OUT

	Mini-stereo jack (1)
Input	TTL level
Output	Contact closure: active short
	Output impedance: 220 ohms
	Signal level: High (3.7 V DC)

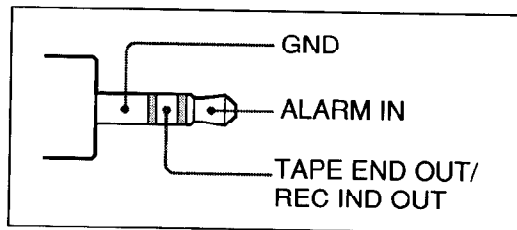

Pin assignment of the plug for this jack

General

Power requirements

7.2 V DC supplied from the battery via the PAD-250

8.4 V DC supplied from the AC/DC adaptor via the PAD-250

Power consumption

1.0 W

Operating temperature

5°C to 40°C
(41°F to 104°F)

Storage temperature

-20°C to 60°C
(-4°F to 140°F)

Dimensions 69.2 × 60.6 × 134.4 mm

(2³/₄ × 2¹/₂ × 5³/₈ inches) (w/h/d)

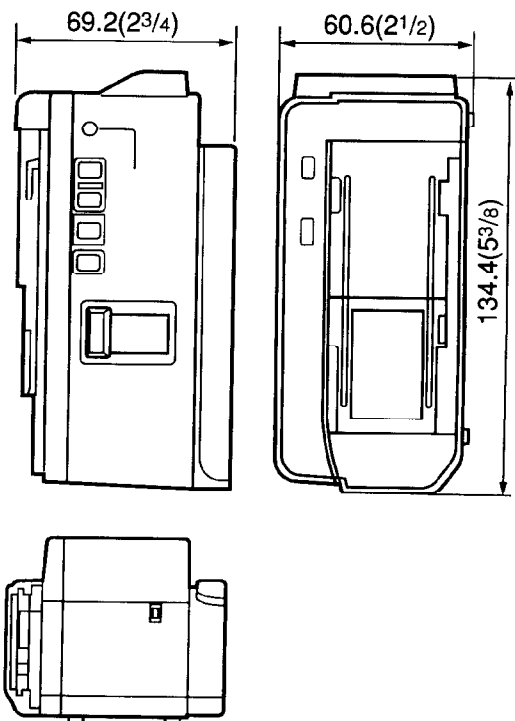

Unit: mm (inches)

Specifications

- Mass** PGV-250/250P main unit
 Approx 170g (5 oz)
 PAD-250 Battery
 Adaptor
 Approx 70g (2 oz)
- Accessories supplied**
 PAD-250 Battery
 Adaptor (1)
 DC power cord (1)
 Branch cable with mini-
 stereo plugs (1)
 S-video cable (1)
 A/V cable (1)
 CR2032 Lithium Battery
 (1)

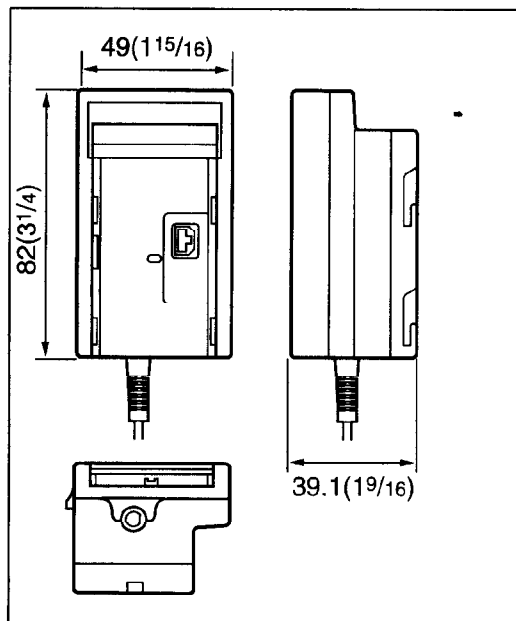

PAD-250 Battery Adaptor

Design and specifications are subject to change without notice.

Relation Between Program Recording Condition and Recording Operation

This section shows the relation between the program recording condition set on this adaptor and the recording operation of the Video Walkman.

For program setting, see page 25.

Duration Setting

Depending on duration settings, recording operations caused by the same alarm signal vary as shown in the figure.

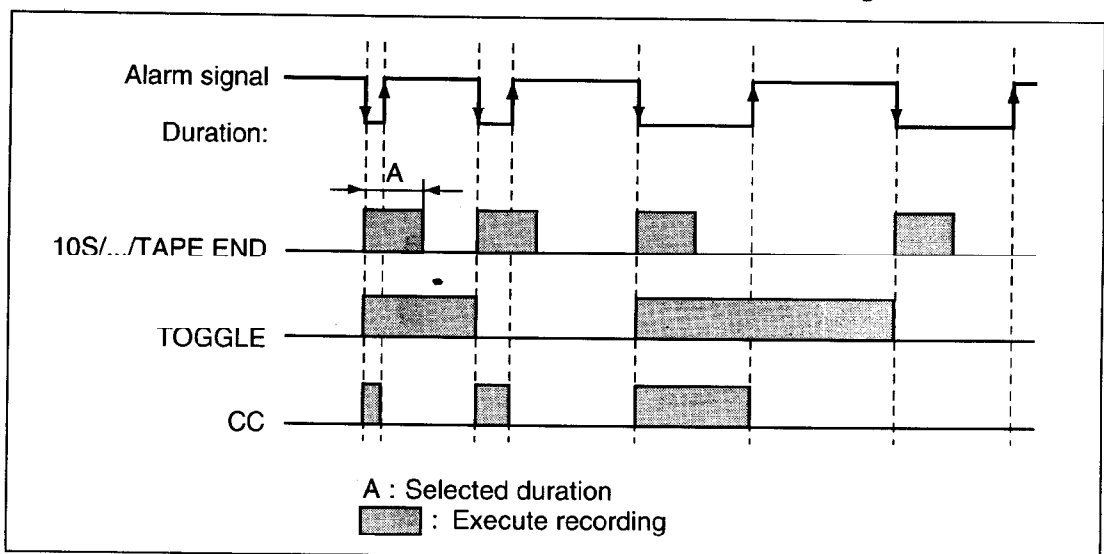

Recording Without Using the Timer

You can select alarm recording (setting the REC MODE SETUP to ALARM) or continuous recording (setting the REC MODE SETUP to CONTI REC).

Relation Between Program Recording Condition and Recording Operation

Alarm recording

Depending on duration settings, recording operations vary as shown in the figure.

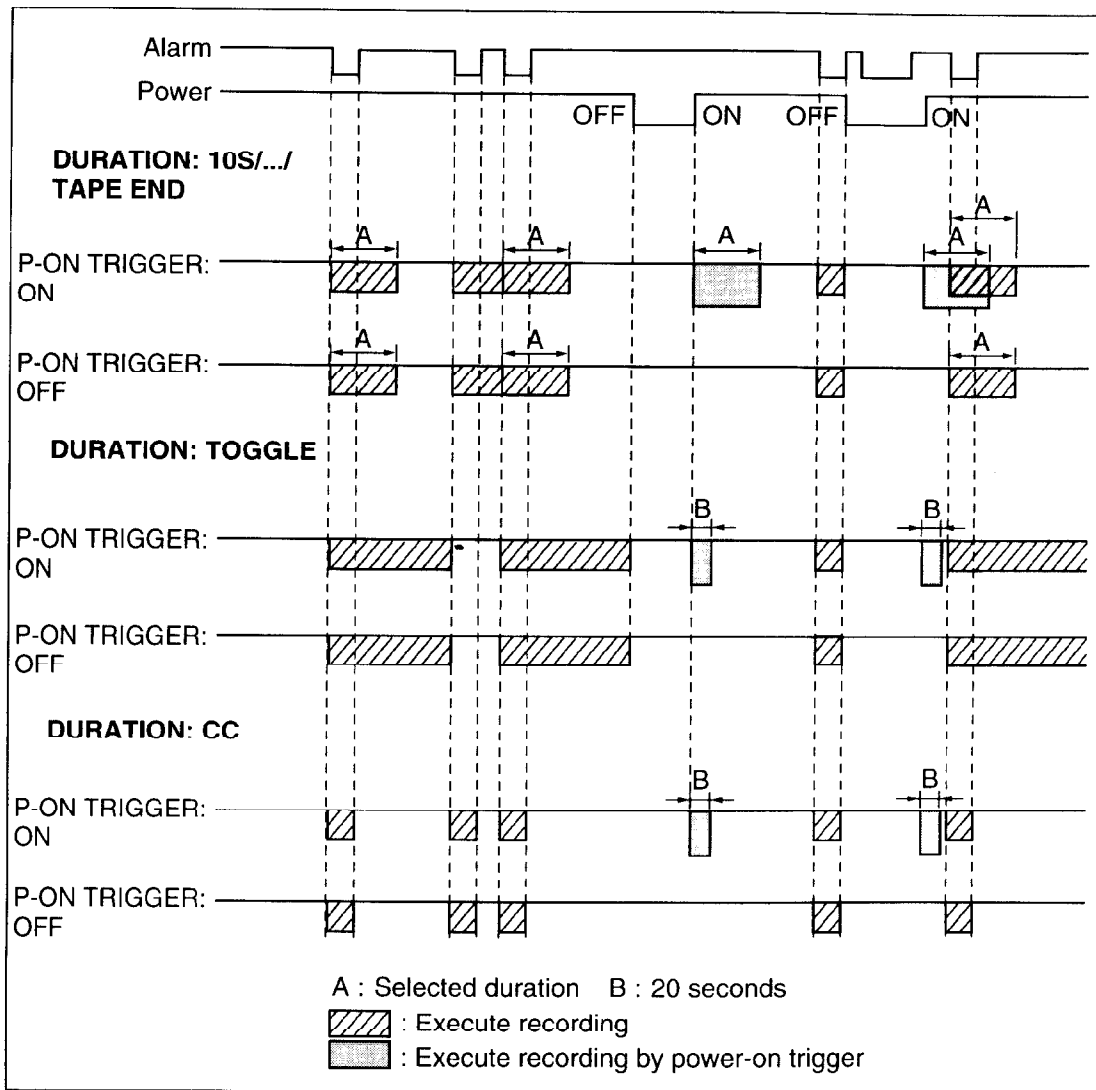

Continuous recording

Once recording starts, regardless of alarm inputs, it continues and stops at power cut or release of the recording mode.

Timer Recording

When you perform timer recording (by setting the REC MODE SETUP to TIMER), you can select alarm recording (setting the MODE in the TIMER SETUP menu to ALM) or continuous recording (setting the MODE in the TIMER SETUP menu to CREC).

If the alarm signals are input before the selected time slot, response to them depends whether ALM OFF is selected for STANDBY.

Here is explained an example operation in the condition where the DURATION is set to TOGGLE.

Alarm recording (setting the MODE in the TIMER SETUP menu to ALM)

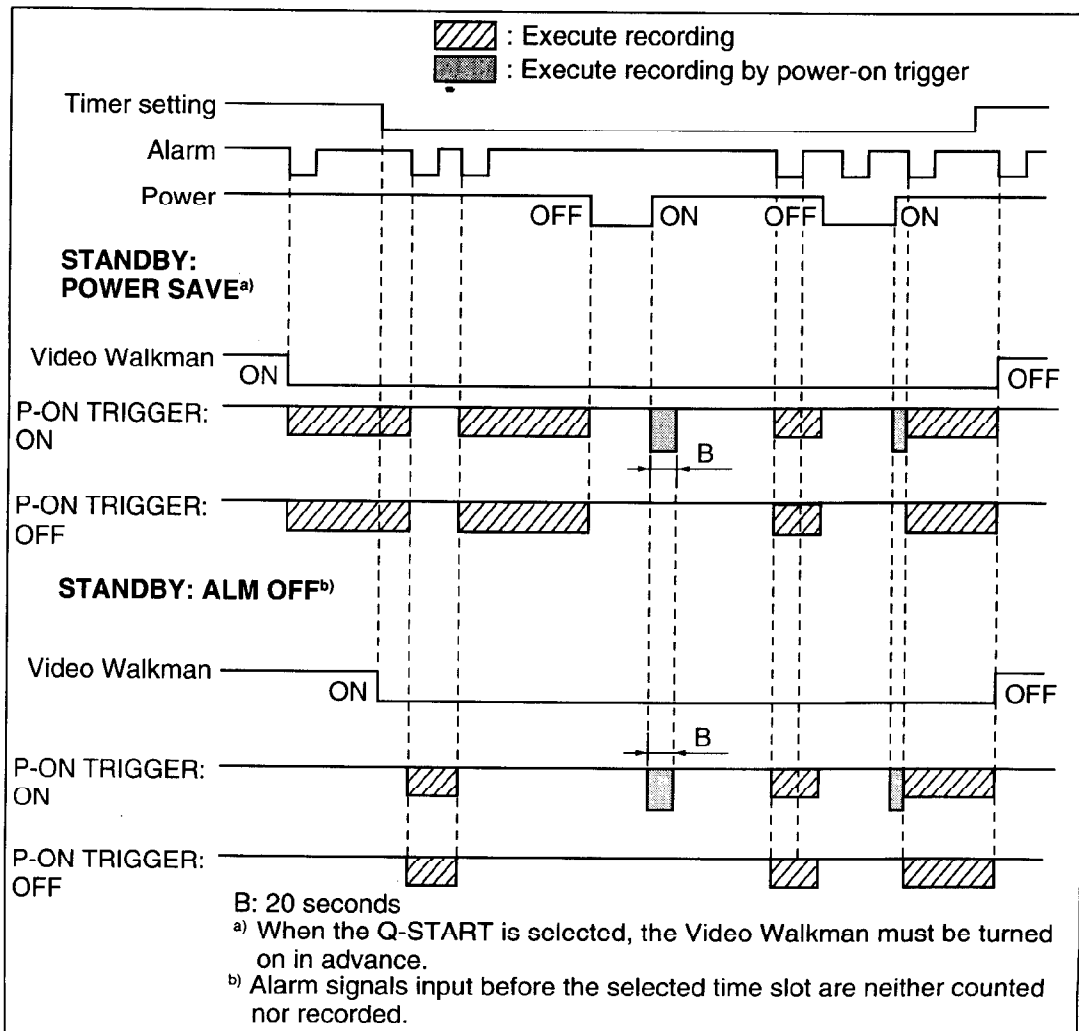

Relation Between Program Recording Condition and Recording Operation

Continuous recording (setting the MODE in the TIMER SETUP menu to CREC)

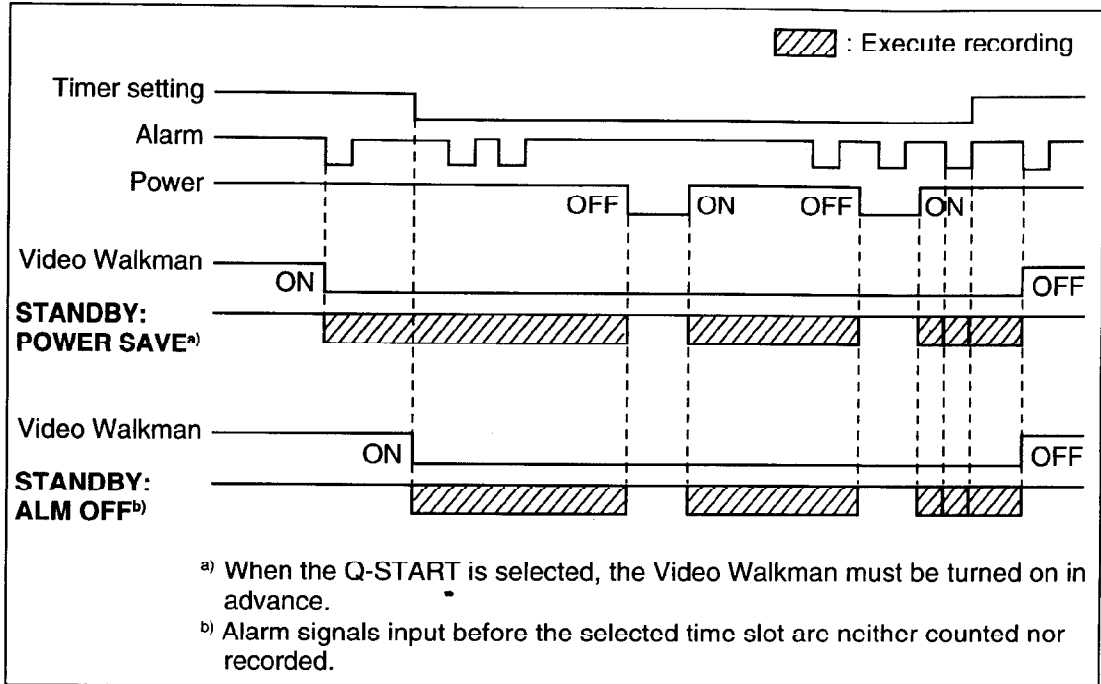

Setting for Your Purpose

The table below shows examples of how to use this adaptor and basic settings.

For details on setting, see page 25.

Purpose	Alarm event/timer setting	Setting
Record while someone is in a room	Alarm: Someone is in the room	REC MODE SETUP: ALARM DURATION: CC (An alarm signal is input while someone is in the room.)
Monitor the inside of a school bus	Alarm: Power-on of this adaptor caused by starting the engine	REC MODE SETUP: CONTI REC DURATION: TAPE END P-ON TRIGGER: ON REPEAT: ON
Monitor an office room on holidays	Timer setting: A certain time slot on holidays	REC MODE SETUP: TIMER DURATION: TAPE END
Operate by foot switch during medical operation or examination	Alarm: Pressing down (or releasing) the switch	REC MODE SETUP: ALARM DURATION: TOGGLE or CC
Monitor a target for a long period	–	REC MODE SETUP: CONTI REC DURATION: TAPE END
Monitor a target for a short period	Alarm: Manual start	REC MODE SETUP: ALARM DURATION: TAPE END

Detailed settings for special cases

If you consider the following cases, it is necessary to make settings other than the settings listed above.

Power failure

Set the P-ON TRIGGER to ON to resume recording when the power recovers.

Saving power

Set the STANDBY to POWER SAVE to keep the Video Walkman turned off until the desired time or alarm input. However, it will delay recording start about 10 seconds.

Quick start of recording

Set the STANDBY to Q-START to keep the Video Walkman turned on.

Recording only at alarm inputs in a time slot

Set the REC MODE SETUP to TIMER and set the MODE to ALM in the TIMER SETUP menu. Also, select ALM OFF for the STANDBY setting to ignore alarm signals input outside the specified time slot.

Setting for Your Purpose

Listing alarms

Set the LIST LOG to ON to log the date, time and cause of an alarm signal. Also, set the LIST REC to ON to automatically record the alarm list on the tape.

SONY

English

Damage verifiably caused to your unit by use of non-InfoLITHIUM ((i) InfoLITHIUM) batteries will not be covered by the limited warranty.

Français

Les dommages causés de manière probante à cet appareil par l'utilisation d'une batterie qui n'est pas de type InfoLITHIUM ((i) InfoLITHIUM) ne seront pas couverts pas la garantie limitée.

Español

Esta garantía limitada no cubre los daños verificables causados a su unidad por no haber utilizado baterías InfoLITHIUM ((i) InfoLITHIUM).

Deutsch

Schäden an Ihrem Gerät, die dadurch entstanden sind, daß kein InfoLITHIUM-Akku ((i) InfoLITHIUM) verwendet wurde, werden nicht durch die Garantie gedeckt.

Nederlands

Schade aan uw apparatuur, die aantoonbaar is veroorzaakt door het gebruik van andere dan InfoLITHIUM ((i) InfoLITHIUM) batterijen, wordt niet gedekt door de beperkte garantie.

Svenska

Skador på denna produkt som bevisligen uppstått till följd av att ett annat batteri än ett InfoLITHIUM-batteri ((i) InfoLITHIUM) använts täcks inte av produktens begränsade garanti.

Italiano

I danni causati in modo verificabile all'apparecchio dall'uso di blocchi batteria non InfoLITHIUM ((i) InfoLITHIUM) non sono coperti dalla garanzia limitata.

Português

Avarias neste aparelho comprovadamente causadas pelo uso de baterias não-InfoLITHIUM ((i) InfoLITHIUM) não serão cobertas pela garantia limitada.

Русский

Повреждение Вашего аппарата, которое было вызвано из-за использования отличных от InfoLITHIUM (InfoLITHIUM) батарейных блоков, не охватывается ограниченной гарантией.

Polski

Ograniczona gwarancja nie obejmuje usunięcia uszkodzeń sprzętu, powstałych na skutek udowodnionego korzystania z innych niż InfoLITHIUM (InfoLITHIUM) typu baterii.

中文 (繁)

確實是由於使用非 InfoLITHIUM (InfoLITHIUM) 電池而造成的損壞不在保修範圍以內。

中文 (簡)

确实是由于使用非 InfoLITHIUM (InfoLITHIUM) 电池而造成的损坏不在保修范围以内。

عربي

لا يتم تغطية الخلل الناتج لوحدها بسبب استعمال بطاريات ليست انفوليثيوم (InfoLITHIUM) بشهادة الضمان.

فارسی

خرابی های احتمالی ناشی از عدم استفاده از باتری های InfoLITHIUM (InfoLITHIUM) مشمول این گارانتی نمی شوند.

한국어

InfoLITHIUM (InfoLITHIUM) 이외의 배터리를 사용한 것이 원인으로 장치가 손상된 것이 증명되었을 경우는 보증의 대상에서 제외됩니다.

English

Attaching the mounting adaptor

Remove the screws at the bottom of the VCR.

Attach the mounting adaptor (A) using the screws (B) supplied with the mounting adaptor.

Français

Installation de l'adaptateur de montage

Déposez les vis à la base du magnétoscope.

Installez l'adaptateur de montage (A) à l'aide des vis (B) fournies avec l'adaptateur de montage.

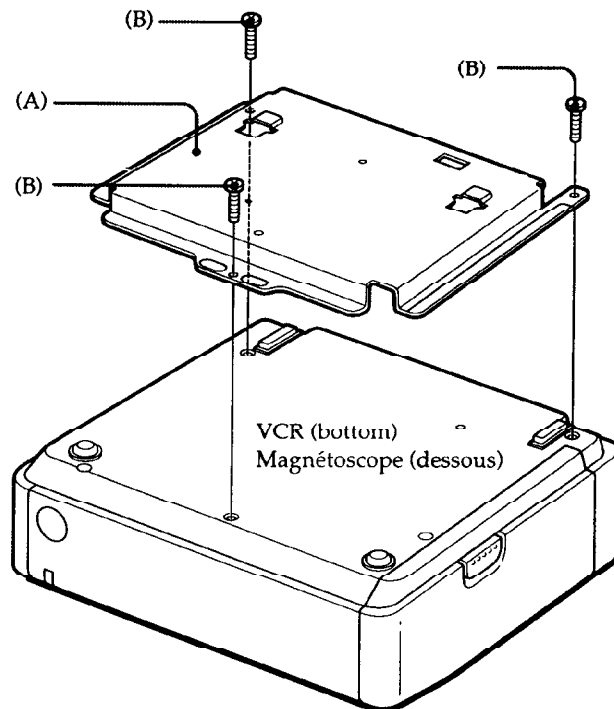

SONY[®]
THIS PRODUCT IS FOR PROFESSIONAL USE

BUSINESS AND PROFESSIONAL GROUP

LIMITED WARRANTY

Sony Electronics Inc. ("Sony") warrants this Product to be free from defects in material or workmanship as follows:

A. Labor: For a period of ninety (90) days from the date of purchase, Sony will, at no charge, repair this Product if determined by Sony to be defective. After the warranty period, the Purchaser must pay all labor charges.

B. Parts: For a period of one (1) year from the date of purchase Sony will, at no charge, supply new or rebuilt replacement parts for parts determined by Sony to be defective. After the warranty period, the Purchaser must pay all parts charges.

C. Exceptions: Exceptions or limitations to the preceding labor and parts warranty coverage on selected Products are as follows:

PRODUCT WARRANTY COVERAGE

• DNV Recorder/Player
• Labor: 1 year
• Parts: 3 years, except Hard Disk Drive which is warranted for 5 years.

• DNV/DNV Decodable Camcorder VTR and One-piece Camcorder
• Labor: 1 year
• Parts: 3 years

• DVW Recorder/Player
• Labor: 1 year
• Parts: 1 year except DVW Mid-Drum Assembly which is warranted for 1,500 operating hours or 1 year, whichever occurs first. Full credit towards replacement provided during first 1,000 hours. Thereafter, credit towards replacement provided as follows:
Credit = $\frac{\text{Current Asy Price} \times (\text{1,500 Hours} - \text{Actual Head Usage Hours})}{1,000 \text{ Hours}}$

• BVW/PVW/DVW Recorder/Player
• Labor: 1 year
• Parts: 1 year, except Rotary Upper Drum Assembly which is warranted for 1,500 operating hours or 1 year, whichever occurs first. Full credit towards replacement provided during first 500 hours. Thereafter, credit towards replacement provided as follows:
Credit = $\frac{\text{Current Asy Price} \times (\text{1,500 Hours} - \text{Actual Head Usage Hours})}{1,000 \text{ Hours}}$

• DVW/BVW/BV/ PVV/DVW Decodable Camcorder VTR & One-piece Camcorder
• Labor: 1 year
• Parts: 1 year, except a.) Camcorder Camera CCD Prism Block which is warranted for 2 years, and b.) Rotary Upper Drum Assembly which is warranted for 1,000 operating hours or 1 year, whichever occurs first. Full credit towards replacement provided during first 500 hours. Thereafter, credit towards replacement provided as follows:
Credit = $\frac{\text{Current Asy Price} \times (\text{1,000 Hours} - \text{Actual Head Usage Hours})}{500 \text{ Hours}}$

2. EXCLUSIVE REMEDY; ACCEPTANCE: Purchaser's exclusive remedy and Sony's sole obligation is to supply (or pay for) all labor necessary to repair any Product found to be defective within the warranty period and to supply, at no extra charge, new or rebuilt replacements for defective parts. If repair or replacement fails to remedy the defect, then, and only in such event, shall Sony endeavor to purchase the purchase price for such Product. Purchaser's failure to make a claim as provided in paragraph 1 above or continued use of the Product shall constitute an unqualified acceptance of such Product and waiver by Purchaser of all claims thereon.

3. EXCEPTIONS TO LIMITED WARRANTY: Sony shall have no liability or obligation to Purchaser with respect to any Product requiring service during the warranty period which is subjected to any of the following: abuse, improper use, negligence, accident, modification, failure of the end-user to follow the operating procedures outlined in the user's manual, failure of the end-user to follow the maintenance procedures in the service manual for the Product where a schedule is specified for regular replacement or maintenance or cleaning of certain parts (based on usage) and the end-user has failed to follow such schedule; attempted repair by non-qualified persons; use, operation of the Product outside of the published environmental and electrical parameters; or if such Product's original identification (trademark, serial number) markings have been defaced, altered, or removed. Sony's original identification coverage Products sold AS IS and/or WITH ALL FAULTS and excludes used Products which have not been sold by Sony to the Purchaser. Sony also excludes from warranty coverage Products located outside of the United States and Puerto Rico, and consumable items such as fuses and batteries.

All software and accompanying documentation furnished with, or as part of the Product is furnished "AS IS" (i.e., without any warranty of any kind) except where expressly provided otherwise in any documentation or license agreement furnished with the Product.

4. PROOF OF PURCHASE: The Purchaser's dated bill of sale must be retained as evidence of the date of purchase and to establish warranty eligibility.

DISCLAIMER OF WARRANTY

EXCEPT FOR THE FOREGOING WARRANTIES, SONY HEREBY DISCLAIMS AND EXCLUDES ALL OTHER WARRANTIES, EXPRESS OR IMPLIED, INCLUDING, BUT NOT LIMITED TO ANY AND/OR ALL IMPLIED WARRANTIES OF MERCHANTABILITY, FITNESS FOR A PARTICULAR PURPOSE AND/OR ANY WARRANTY WITH REGARD TO ANY CLAIM OF INFRINGEMENT THAT MAY BE PROVIDED IN SECTION 2.312(3) OF THE UNIFORM COMMERCIAL CODE AND/OR IN ANY OTHER COMPARABLE STATE STATUTE. SONY HEREBY DISCLAIMS ANY REPRESENTATIONS OR WARRANTIES THAT THE PRODUCTS COMPATIBLE WITH ANY COMBINATOR OF NON-SONY PRODUCTS PURCHASER MAY CHOOSE TO CONNECT TO THE PRODUCT.

LIMITATION OF LIABILITY

THE LIABILITY OF SONY, IF ANY, AND PURCHASER'S SOLE AND EXCLUSIVE REMEDY FOR DAMAGES FOR ANY CLAIM OF ANY KIND WHATSOEVER, REGARDLESS OF THE LEGAL THEORY AND WHETHER ARISING IN TORT OR CONTRACT, SHALL NOT BE GREATER THAN THE ACTUAL PURCHASE PRICE OF THE PRODUCT WITH RESPECT TO WHICH SUCH CLAIM IS MADE. IN NO EVENT SHALL SONY BE LIABLE TO PURCHASER FOR ANY SPECIAL, INDIRECT, INCIDENTAL, OR CONSEQUENTIAL DAMAGES OF ANY KIND INCLUDING, BUT NOT LIMITED TO, COMPENSATION, REIMBURSEMENT OR DAMAGES ON ACCOUNT OF THE LOSS OF PRESENT OR FUTURE PROFITS OR FOR ANY OTHER REASON WHATSOEVER.

For further information and the name of the nearest authorized Sony service facility contact:

Sony Electronics Inc.
Business and Professional Group
Customer and Engineering Services
3300 Zanker Road, San Jose, California 95134-1901
(408) 432-9000